

WASHERS, SHOULDER WASHERS & SCREW INSULATORS

SECTION IV

RETAINING WASHERS

Molded in Natural Nylon 6/6



Similar to our standard flat washers, but with a specially configured I.D. designed to grip the outside of the screw shank. The washer slides on the screw easily, but is retained on the screw. For use in applications requiring pre-assembly of the screw and washer, to reduce final assembly cost.

Other sizes will be tooled on request.

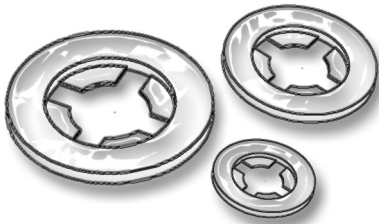
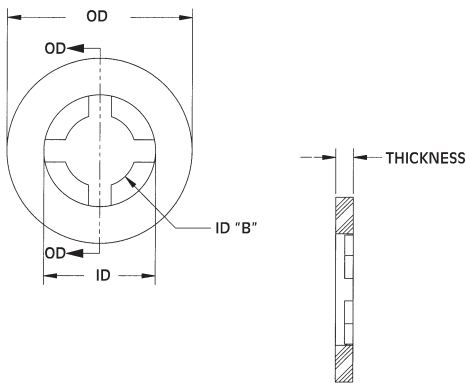

ITEM NUMBER	SCREW SIZE	OD	ID	ID "B"	THICKNESS
16FWRT002032	2	13/64 (5,16)	.115 (2,92)	.078 (1,98)	.032 (0,81)
16FWRT002062	2	13/64 (5,16)	.115 (2,92)	.078 (1,98)	.062 (1,58)
16FWRT004032	4	17/64 (6,75)	.156 (3,96)	.102 (2,59)	.032 (0,81)
16FWRT004050	4	1/4 (25,40)	.156 (3,96)	.102 (2,59)	.050 (1,27)
16FWRT004062	4	17/64 (6,75)	.156 (3,96)	.102 (2,59)	.062 (1,58)
16FWRT004125	4	17/64 (6,75)	.156 (3,96)	.102 (2,59)	.125 (3,18)
16FWRT006032	6	21/64 (8,33)	.198 (5,03)	.128 (3,25)	.032 (0,81)
16FWRT006062	6	21/64 (8,33)	.198 (5,03)	.128 (3,25)	.062 (1,58)
16FWRT007062	7	.750 (19,05)	.375 (9,53)	.215 (5,46)	.062 (1,58)
16FWRT007062A	7	1.000 (25,40)	.375 (9,53)	.215 (5,46)	.062 (1,58)
16FWRT008032	8	25/64 (9,92)	.235 (5,97)	.152 (3,86)	.032 (0,81)
16FWRT008032A	8	.390 (9,91)	.235 (5,97)	.135 (3,43)	.032 (0,81)
16FWRT008032C	8	.328 (8,33)	.235 (5,96)	.152 (3,86)	.032 (0,81)
16FWRT008045	8	.453 (11,51)	.218 (5,54)	.135 (3,43)	.045 (1,14)
16FWRT008062	8	25/64 (9,92)	.235 (5,97)	.152 (3,86)	.062 (1,58)
16FWRT010032	10	29/64 (11,51)	.277 (7,04)	.177 (4,50)	.032 (0,81)
16FWRT010059	10	.787 (19,99)	.275 (6,99)	.177 (4,50)	.059 (1,50)
16FWRT010062	10	29/64 (11,51)	.277 (7,04)	.177 (4,50)	.062 (1,58)
16FWRT010062A	10	1/2 (12,70)	.277 (7,04)	.177 (4,50)	.062 (1,58)
16FWRT010062C	10	.630 (16,00)	.277 (7,04)	.177 (4,50)	.062 (1,58)
16FWRT250032	1/4	19/32 (15,08)	.375 (9,53)	.234 (5,94)	.032 (0,81)
16FWRT250032A	1/4	.500 (12,70)	.344 (8,74)	.234 (5,94)	.032 (0,81)
16FWRT250062	1/4	19/32 (15,08)	.375 (9,53)	.234 (5,94)	.062 (1,58)
16FWRT250062A	1/4	1-1/2 (38,10)	.450 (11,43)	.234 (5,94)	.062 (1,58)
16FWRT250062C	1/4	1-1/2 (38,10)	.375 (9,53)	.234 (5,94)	.062 (1,58)
16FWRT250062E	1/4	.734 (18,64)	.375 (9,53)	.234 (5,94)	.062 (1,57)
16FWRT312032	5/16	47/64 (18,65)	.470 (11,94)	.292 (7,42)	.032 (0,81)
16FWRT312062	5/16	47/64 (18,65)	.470 (11,94)	.292 (7,42)	.062 (1,58)
16FWRT375032	3/8	57/64 (22,62)	.564 (14,33)	.350 (8,89)	.032 (0,81)
16FWRT375062	3/8	57/64 (22,62)	.564 (14,33)	.350 (8,89)	.062 (1,58)
16FWRT375062A	3/8	1.260 (32,00)	.563 (14,30)	.350 (8,89)	.062 (1,58)
16FWRT375062C	3/8	47/64 (18,65)	.564 (14,33)	.350 (8,89)	.062 (1,58)
16FWRT437032	7/16	1-1/32 (26,19)	.570 (14,48)	.410 (10,41)	.032 (0,81)
16FWRT437062	7/16	1-1/32 (26,19)	.570 (14,48)	.410 (10,41)	.062 (1,58)
16FWRT500032	1/2	1-1/8 (28,58)	.690 (17,53)	.468 (11,89)	.032 (0,81)
16FWRT500062	1/2	1-1/8 (28,58)	.690 (17,53)	.468 (11,89)	.062 (1,58)
16FWRT875062	7/8	1-11/32 (34,14)	.940 (23,88)	.825 (20,96)	.062 (1,58)
16FWRT999062	1	1.385 (35,18)	1.070 (27,18)	.970 (24,64)	.062 (1,58)

FINISHING WASHERS

Molded in Natural Nylon 6/6

Available in natural or black nylon, these molded washers protect cabinets from scratching, cover misaligned holes, etc. May also be used as glides, bumpers, feet, and spacers.

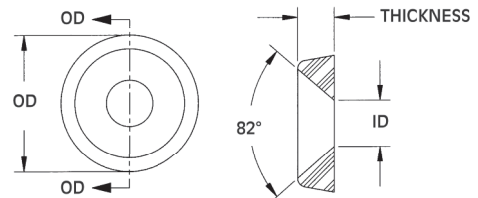

ITEM NUMBER	FITS SCREW	OD	ID	THICKNESS
11SFW0006	6	.437 (11,10)	.143 (3,63)	.100 (2,54)
11SFW0008	8	.510 (12,95)	.171 (4,34)	.115 (2,92)
11SFW0010	10	.575 (14,61)	.196 (4,98)	.152 (3,86)
11SFW0012	12	.609 (15,47)	.225 (5,75)	.160 (4,06)
11SFW0025	1/4	.683 (17,35)	.260 (6,61)	.180 (4,57)

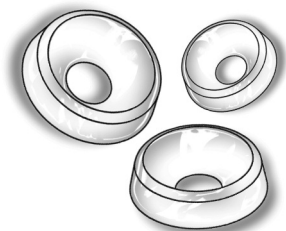

STANDARD FLAT WASHERS

Molded in Natural Nylon 6/6

We will also tool custom flat washers for a nominal engineering charge .

**METRIC Sizes
Also Available**

Page 277

ITEM NUMBER	DESCRIPTION	OD	ID	THICKNESS
16FW002032	FW 2-032	1/4 (6,35)	.090 (2,29)	.032 (0,81)
16FW002062	FW 2-062	1/4 (6,35)	.090 (2,29)	.062 (1,58)
16FW002093	FW 2-093	1/4 (6,35)	.090 (2,29)	.093 (2,36)
16FW002125	FW 2-125	1/4 (6,35)	.090 (2,29)	.125 (3,18)
16FW004032	FW 4-032	1/4 (6,35)	.115 (2,92)	.032 (0,81)
16FW004062	FW 4-062	1/4 (6,35)	.115 (2,92)	.062 (1,58)
16FW004093	FW 4-093	1/4 (6,35)	.115 (2,92)	.093 (2,36)
16FW004125	FW 4-125	1/4 (6,35)	.115 (2,92)	.125 (3,18)
16FW006032	FW 6-032	5/16 (7,94)	.140 (3,56)	.032 (0,81)
16FW006062	FW 6-062	5/16 (7,94)	.140 (3,56)	.062 (1,58)
16FW006093	FW 6-093	5/16 (7,94)	.140 (3,56)	.093 (2,36)
16FW006125	FW 6-125	5/16 (7,94)	.140 (3,56)	.125 (3,18)
16FW008032	FW 8-032	3/8 (9,53)	.171 (4,34)	.032 (0,81)
16FW008062	FW 8-062	3/8 (9,53)	.171 (4,34)	.062 (1,58)
16FW008093	FW 8-093	3/8 (9,53)	.171 (4,34)	.093 (2,36)
16FW008125	FW 8-125	3/8 (9,53)	.171 (4,34)	.125 (3,18)
16FW010032	FW 10-032	3/8 (9,53)	.194 (4,93)	.032 (0,81)
16FW010062	FW 10-062	3/8 (9,53)	.194 (4,93)	.062 (1,58)
16FW010093	FW 10-093	3/8 (9,53)	.194 (4,93)	.093 (2,36)
16FW010125	FW 10-125	3/8 (9,53)	.194 (4,93)	.125 (3,18)
16FW250032	FW 250-032	1/2 (12,70)	.257 (6,53)	.032 (0,81)
16FW250062	FW 250-062	1/2 (12,70)	.257 (6,53)	.062 (1,58)
16FW250093	FW 250-093	1/2 (12,70)	.257 (6,53)	.093 (2,36)
16FW250125	FW 250-125	1/2 (12,70)	.257 (6,53)	.125 (3,18)
16FW312032	FW 312-032	1/2 (12,70)	.317 (8,05)	.032 (0,81)
16FW312062	FW 312-062	1/2 (12,70)	.317 (8,05)	.062 (1,58)
16FW312093	FW 312-093	1/2 (12,70)	.317 (8,05)	.093 (2,36)
16FW312125	FW 312-125	1/2 (12,70)	.317 (8,05)	.125 (3,18)
16FW375032	FW 375-032	5/8 (15,88)	.375 (9,53)	.032 (0,81)
16FW375062	FW 375-062	5/8 (15,88)	.380 (9,65)	.062 (1,58)
16FW375093	FW 375-093	5/8 (15,88)	.380 (9,65)	.093 (2,36)
16FW375125	FW 375-125	5/8 (15,88)	.380 (9,65)	.125 (3,18)
16FW437032	FW 437-032	3/4 (19,05)	.443 (11,25)	.032 (0,81)
16FW437062	FW 437-062	3/4 (19,05)	.443 (11,25)	.062 (1,58)
16FW437093	FW 437-093	3/4 (19,05)	.443 (11,25)	.093 (2,36)
16FW437125	FW 437-125	3/4 (19,05)	.443 (11,25)	.125 (3,18)
16FW500032	FW 500-032	3/4 (19,05)	.505 (12,83)	.032 (0,81)
16FW500062	FW 500-062	3/4 (19,05)	.505 (12,83)	.062 (1,58)
16FW500093	FW 500-093	3/4 (19,05)	.505 (12,83)	.093 (2,36)
16FW500125	FW 500-125	3/4 (19,05)	.505 (12,83)	.125 (3,18)

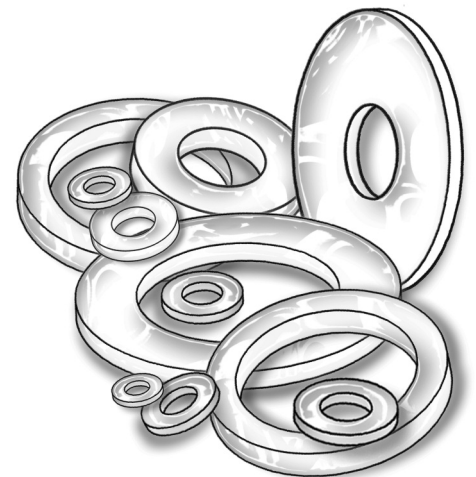
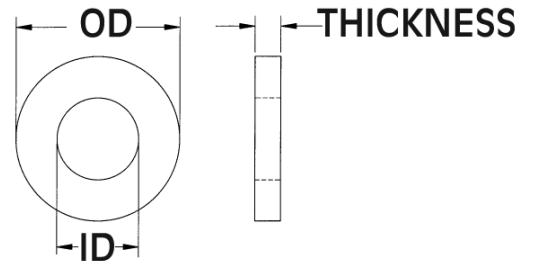

WASHERS, SHOULDER WASHERS & SCREW INSULATORS

SECTION
IV

New
SIZES

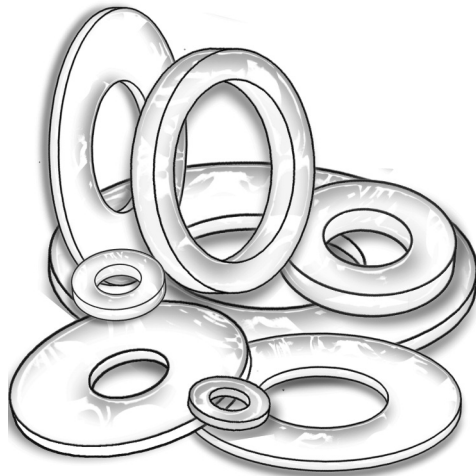
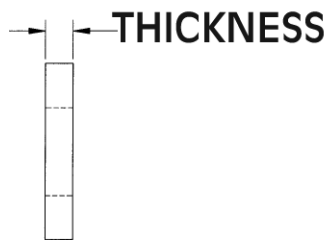
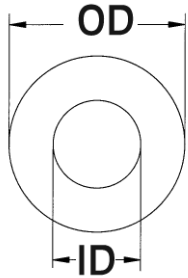

SPECIAL FLAT WASHERS

Molded in Natural Nylon 6/6

ITEM NUMBER	DESCRIPTION	OD	ID	THICKNESS
17W00850	W 850	.085 (2,16)	.032 (0,81)	.062 (1,57)
17W00901	W 901	.090 (2,29)	.031 (0,79)	.031 (0,79)
17W01001	W 1001	.100 (2,54)	.035 (0,89)	.020 (0,51)
17W01010	W 1010	.125 (3,17)	.047 (1,19)	.125 (3,17)
17W01011	W 1011	.125 (3,18)	.032 (0,81)	.060 (1,57)
17W01012	W 1012	.120 (3,05)	.063 (1,60)	.180 (4,57)
17W01013	W 1013	.120 (3,05)	.045 (1,14)	.130 (3,30)
17W01014	W 1014	.120 (3,05)	.055 (1,40)	.080 (2,03)
17W01015	W 1015	.120 (3,05)	.090 (2,29)	.180 (4,57)
17W01016	W 1016	.125 (3,18)	.059 (1,50)	.125 (3,18)
17W01017	W 1017	.125 (3,18)	.070 (1,78)	.090 (2,29)
17W01018	W 1018	.127 (3,23)	.065 (1,65)	.040 (1,02)
17W01019	W 1019	.125 (3,17)	.070 (1,77)	.062 (1,57)
17W01045	W 1045	.156 (3,96)	.031 (0,79)	.062 (1,57)
17W01381	W 1381	.138 (3,51)	.040 (1,02)	.033 (0,84)
17W01480	W 1480	.148 (3,76)	.085 (2,16)	.062 (1,57)
17W01481	W 1481	.145 (3,68)	.071 (1,80)	.067 (1,70)
17W01560	W 1560	.156 (3,96)	.050 (2,00)	.200 (5,08)
17W01561	W 1561	.156 (3,96)	.085 (2,16)	.200 (5,08)
17W01562	W 1562	.156 (3,96)	.091 (2,31)	.250 (6,35)
17W01566	W 1566	.156 (3,96)	.076 (1,93)	.062 (1,57)
17W01581	W 1581	.158 (4,01)	.110 (2,79)	.070 (1,79)
17W01582	W 1582	.157 (3,99)	.102 (2,59)	.098 (2,49)
17W01701	W 1701	.170 (4,32)	.038 (0,97)	.060 (1,52)
17W01702	W 1702	.182 (4,62)	.120 (3,05)	.125 (3,17)
17W01783	W 1783	.167 (4,24)	.106 (2,69)	.039 (0,99)
17W01784	W 1784	.178 (4,52)	.098 (2,49)	.045 (1,14)
17W01785	W 1785	.170 (4,32)	.110 (2,79)	.020 (0,51)
17W01786	W 1786	.165 (4,19)	.085 (2,15)	.056 (1,42)
17W01791	W 1791	.179 (4,55)	.065 (1,65)	.078 (1,98)
17W01801	W 1801	.187 (4,75)	.125 (3,18)	.050 (1,27)
17W01802	W 1802	.180 (4,57)	.139 (3,53)	.064 (1,63)
17W01803	W 1803	.186 (4,72)	.098 (2,49)	.030 (1,02)
17W01804	W 1804	.187 (4,75)	.120 (3,05)	.060 (1,52)
17W01805	W 1805	.187 (4,75)	.086 (2,18)	.130 (3,30)
17W01806	W 1806	.187 (4,75)	.145 (3,68)	.050 (1,27)
17W01807	W 1807	.187 (4,75)	.120 (3,05)	.032 (0,81)
17W01809	W 1809	.187 (4,75)	.141 (3,58)	.125 (3,18)
17W01811	W 1811	.187 (4,75)	.115 (2,92)	.165 (4,19)
17W01812	W 1812	.188 (4,78)	.089 (2,26)	.141 (3,58)
17W01813	W 1813	.187 (4,75)	.116 (2,95)	.109 (2,77)
17W01814	W 1814	.188 (4,78)	.115 (2,92)	.040 (1,02)
17W01815	W 1815	.190 (4,83)	.094 (2,39)	.020 (0,51)
17W01816	W 1816	.187 (4,74)	.093 (2,36)	.078 (1,98)
17W01825	W 1825	.196 (4,98)	.085 (2,16)	.031 (0,79)
17W01870	W 1870	.187 (4,75)	.120 (3,05)	.062 (1,57)
17W01871	W 1871	.185 (4,70)	.051 (1,30)	.132 (3,35)
17W01872	W 1872	.187 (4,75)	.091 (2,31)	.080 (2,03)
17W01874	W 1874	.187 (4,75)	.120 (3,05)	.156 (3,96)
17W01875	W 1875	.187 (4,75)	.130 (3,30)	.150 (3,81)
17W01876	W 1876	.187 (4,75)	.090 (2,29)	.175 (4,45)
17W01877	W 1877	.185 (4,69)	.131 (3,32)	.171 (4,34)
17W01900	W 1900	.199 (5,05)	.115 (2,95)	.050 (1,27)



WASHERS, SHOULDER WASHERS & SCREW INSULATORS

SECTION
IV

SPECIAL FLAT WASHERS

Molded in **Natural Nylon 6/6**

ITEM NUMBER	DESCRIPTION	OD	ID	THICKNESS
17W01906	W 1906	.206 (5,23)	.112 (2,84)	.053 (1,35)
17W01910	W 1910	.190 (4,83)	.120 (3,05)	.100 (2,54)
17W01950	W 1950	.197 (5,00)	.115 (2,92)	.030 (0,76)
17W01970	W 1970	.197 (5,00)	.100 (2,54)	.156 (3,96)
17W01971	W 1971	.197 (5,00)	.067 (1,70)	.154 (3,91)
17W01994	W 1994	.199 (5,05)	.125 (3,18)	.045 (1,14)
17W02181	W 2181	.218 (5,54)	.120 (3,05)	.037 (0,94)
17W02190	W 2190	.220 (5,59)	.104 (2,64)	.031 (0,79)
17W02191	W 2191	.219 (5,56)	.094 (2,39)	.100 (2,54)
17W02192	W 2192	.228 (5,79)	.122 (3,10)	.093 (2,36)
17W02245	W 2245	.225 (5,72)	.150 (3,81)	.045 (1,14)
17W02251	W 2251	.225 (5,72)	.125 (3,18)	.100 (2,54)
17W02252	W 2252	.225 (5,72)	.150 (3,81)	.090 (2,29)
17W02348	W 2348	.344 (8,73)	.239 (6,07)	.125 (3,18)
17W02349	W 2349	.234 (5,94)	.141 (3,58)	.095 (2,41)
17W02350	W 2350	.235 (5,97)	.125 (3,18)	.040 (1,02)
17W02351	W 2351	.236 (5,99)	.126 (3,20)	.079 (2,01)
17W02352	W 2352	.236 (5,99)	.148 (3,76)	.118 (3,00)
17W02353	W 2353	.236 (5,99)	.126 (3,20)	.187 (1,57)
17W02354	W 2354	.236 (5,99)	.142 (3,60)	.045 (1,14)
17W02401	W 2401	.240 (6,10)	.113 (2,87)	.040 (1,02)
17W02450	W 2450	.245 (6,22)	.195 (4,95)	.125 (3,18)
17W02451	W 2451	.245 (6,22)	.128 (3,25)	.093 (2,36)
17W02452	W 2452	.236 (5,99)	.102 (2,59)	.098 (2,49)
17W02453	W 2453	.245 (6,22)	.195 (4,95)	.062 (1,57)
17W02460	W 2460	.248 (6,30)	.171 (4,34)	.100 (2,54)
17W02500	W 2500	.250 (6,35)	.120 (3,05)	.140 (3,56)
17W02501	W 2501	.250 (6,35)	.160 (4,07)	.062 (1,57)
17W02502	W 2502	.250 (6,35)	.126 (3,20)	.025 (0,64)
17W02503	W 2503	.250 (6,35)	.090 (2,29)	.055 (1,40)
17W02504	W 2504	.250 (6,35)	.141 (3,58)	.062 (1,57)
17W02505	W 2505	.260 (6,60)	.140 (3,56)	.080 (2,03)
17W02506	W 2506	.250 (6,35)	.125 (3,18)	.095 (2,41)
17W02507	W 2507	.250 (6,35)	.140 (3,56)	.094 (2,39)
17W02508	W 2508	.250 (6,35)	.125 (3,18)	.062 (1,57)
17W02509	W 2509	.250 (6,35)	.171 (4,34)	.100 (2,54)
17W02510	W 2510	.250 (6,35)	.187 (4,75)	.130 (3,30)
17W02511	W 2511	.250 (6,35)	.142 (3,61)	.110 (2,79)
17W02512	W 2512	.250 (6,35)	.147 (3,73)	.125 (3,18)
17W02513	W 2513	.250 (6,35)	.143 (3,63)	.082 (2,08)
17W02514	W 2514	.250 (6,35)	.166 (4,22)	.082 (2,08)
17W02515	W 2515	.250 (6,35)	.140 (3,56)	.150 (3,81)
17W02516	W 2516	.251 (6,38)	.151 (3,84)	.035 (0,88)
17W02517	W 2517	.250 (6,35)	.156 (3,96)	.100 (2,54)
17W02518	W 2518	.250 (6,35)	.125 (3,18)	.150 (3,81)
17W02519	W 2519	.251 (6,38)	.155 (3,94)	.077 (1,96)
17W02520	W 2520	.250 (6,35)	.166 (4,22)	.061 (1,55)
17W02521	W 2521	.250 (6,35)	.147 (3,73)	.156 (3,96)
17W02522	W 2522	.250 (6,35)	.091 (2,31)	.165 (4,19)
17W02523	W 2523	.250 (6,35)	.163 (4,14)	.202 (5,13)
17W02524	W 2524	.250 (6,35)	.161 (4,08)	.170 (4,31)
17W02525	W 2525	.250 (6,35)	.171 (4,34)	.053 (1,34)
17W02526	W 2526	.250 (6,35)	.156 (3,96)	.150 (3,81)

**New
SIZES**

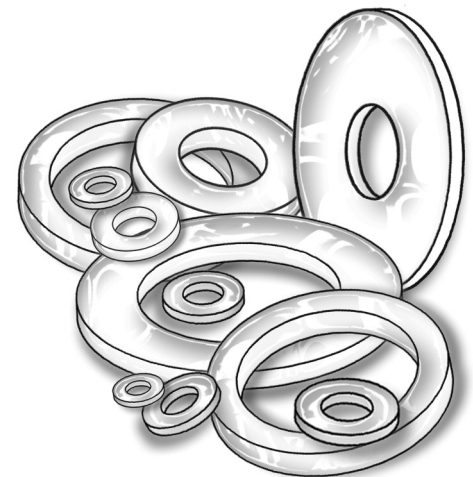
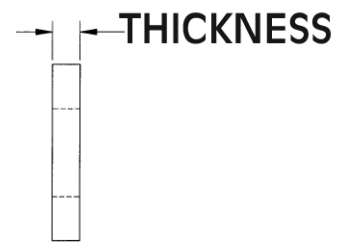
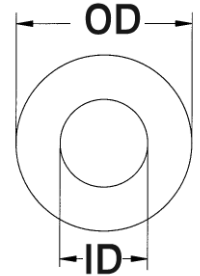

WASHERS, SHOULDER WASHERS & SCREW INSULATORS

SECTION
IV

New
SIZES

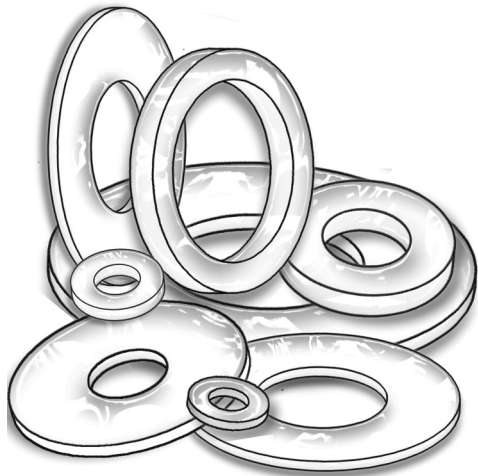
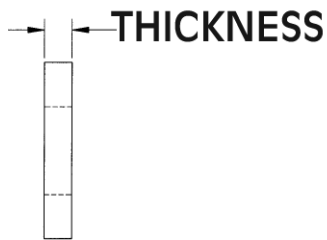
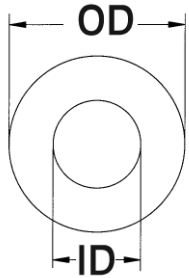

SPECIAL FLAT WASHERS

Molded in Natural Nylon 6/6

ITEM NUMBER	DESCRIPTION	OD	ID	THICKNESS
17W02563	W 2563	.255 (6,47)	.198 (5,02)	.091 (2,31)
17W02564	W 2564	.256 (6,50)	.187 (4,75)	.045 (1,14)
17W02565	W 2565	.254 (6,45)	.161 (4,09)	.219 (5,56)
17W02590	W 2590	.250 (6,35)	.081 (2,06)	.025 (0,63)
17W02591	W 2591	.259 (6,58)	.081 (2,06)	.062 (1,57)
17W02595	W 2595	.295 (7,49)	.135 (3,43)	.127 (3,23)
17W02751	W 2751	.275 (6,99)	.120 (3,05)	.062 (1,57)
17W02752	W 2752	.270 (6,86)	.207 (5,26)	.05 (1,27)
17W02753	W 2753	.276 (7,01)	.138 (3,50)	.035 (0,88)
17W02781	W 2781	.280 (7,11)	.210 (5,33)	.125 (3,18)
17W02801	W 2801	.280 (7,11)	.120 (3,05)	.145 (3,68)
17W02810	W 2810	.280 (7,11)	.150 (3,81)	.108 (2,74)
17W02811	W 2811	.288 (7,32)	.120 (3,05)	.040 (1,02)
17W02812	W 2812	.290 (7,38)	.115 (2,92)	.047 (1,19)
17W02813	W 2813	.280 (7,11)	.120 (3,05)	.030 (0,76)
17W02814	W 2814	.281 (7,14)	.120 (3,05)	.020 (0,51)
17W02815	W 2815	.281 (7,14)	.120 (3,05)	.040 (1,02)
17W02816	W 2816	.281 (7,14)	.120 (3,05)	.060 (1,52)
17W02817	W 2817	.280 (7,11)	.155 (3,94)	.160 (4,06)
17W02818	W 2818	.281 (7,14)	.140 (3,56)	.020 (0,51)
17W02819	W 2819	.281 (7,14)	.107 (2,71)	.020 (0,51)
17W02851	W 2851	.285 (7,24)	.130 (3,30)	.060 (1,52)
17W02852	W 2852	.285 (7,24)	.160 (4,06)	.032 (0,81)
17W02853	W 2853	.280 (7,11)	.200 (5,08)	.093 (2,36)
17W02854	W 2854	.281 (7,14)	.175 (4,44)	.031 (0,79)
17W02862	W 2862	.282 (7,16)	.190 (4,83)	.065 (1,65)
17W02951	W 2951	.295 (7,49)	.220 (5,59)	.127 (3,23)
17W02952	W 2952	.310 (7,87)	.138 (3,50)	.030 (0,76)
17W02953	W 2953	.310 (7,87)	.190 (4,83)	.032 (0,81)
17W02954	W 2954	.310 (7,87)	.185 (4,70)	.032 (0,81)
17W02955	W 2955	.290 (7,37)	.195 (4,95)	.085 (2,16)
17W02956	W 2956	.296 (7,52)	.169 (4,29)	.074 (1,88)
17W02957	W 2957	.312 (7,92)	.192 (4,88)	.092 (2,34)
17W03070	W 3070	.307 (7,80)	.210 (5,33)	.125 (3,18)
17W03071	W 3071	.307 (7,80)	.144 (3,66)	.059 (1,50)
17W03101	W 3101	.310 (7,87)	.160 (4,06)	.060 (1,52)
17W03121	W 3121	.312 (7,92)	.187 (4,75)	.050 (1,27)
17W03122	W 3122	.312 (7,92)	.095 (2,41)	.062 (1,57)
17W03123	W 3123	.318 (8,08)	.130 (3,30)	.062 (1,57)
17W03124	W 3124	.312 (7,92)	.110 (2,79)	.125 (3,18)
17W03125	W 3125	.312 (7,92)	.062 (1,57)	.125 (3,18)
17W03126	W 3126	.312 (7,92)	.115 (2,92)	.140 (3,56)
17W03127	W 3127	.312 (7,92)	.140 (3,56)	.047 (1,19)
17W03128	W 3128	.320 (8,13)	.156 (3,96)	.031 (0,79)
17W03129	W 3129	.312 (7,92)	.228 (5,79)	.250 (6,35)
17W03130	W 3130	.312 (7,92)	.162 (4,11)	.062 (1,57)
17W03131	W 3131	.312 (7,92)	.150 (3,81)	.020 (0,51)
17W03132	W 3132	.312 (7,92)	.125 (3,18)	.032 (0,81)
17W03133	W 3133	.312 (7,92)	.262 (6,65)	.127 (3,23)
17W03134	W 3134	.312 (7,92)	.150 (3,81)	.030 (0,76)
17W03135	W 3135	.312 (7,92)	.192 (4,88)	.110 (2,79)
17W03136	W 3136	.313 (7,95)	.217 (5,51)	.125 (3,18)
17W03137	W 3137	.312 (7,92)	.150 (3,81)	.040 (1,02)



WASHERS, SHOULDER WASHERS & SCREW INSULATORS

SECTION
IV

SPECIAL FLAT WASHERS

Molded in Natural Nylon 6/6

ITEM NUMBER	DESCRIPTION	OD	ID	THICKNESS
17W03138	W 3138	.312 (7,92)	.150 (3,81)	.050 (1,27)
17W03139	W 3139	.312 (7,92)	.150 (3,81)	.060 (1,52)
17W03140	W 3140	5/16 (7,94)	5/32 (3,96)	1/8 (3,18)
17W03141	W 3141	.314 (7,98)	.110 (2,79)	.062 (1,57)
17W03142	W 3142	.312 (7,92)	.260 (6,60)	.070 (1,78)
17W03143	W 3143	.316 (8,03)	.100 (2,54)	.033 (0,84)
17W03145	W 3145	.312 (7,92)	.063 (1,60)	.090 (2,29)
17W03146	W 3146	.312 (7,92)	.140 (3,56)	.020 (0,51)
17W03148	W 3148	.315 (8,00)	.125 (3,18)	.031 (0,79)
17W03149	W 3149	.315 (8,00)	.165 (4,19)	.236 (6,00)
17W03150	W 3150	.315 (8,00)	.157 (3,98)	.197 (5,00)
17W03151	W 3151	.312 (7,92)	.260 (6,60)	.109 (2,77)
17W03221	W 3221	.322 (8,18)	.128 (3,25)	.062 (1,57)
17W03223	W 3223	.330 (8,38)	.189 (4,80)	.080 (2,03)
17W03280	W 3280	.329 (8,36)	.150 (3,81)	.060 (1,52)
17W03281	W 3281	.335 (8,51)	.280 (7,11)	.195 (4,95)
17W03282	W 3282	.332 (8,43)	.255 (6,48)	.142 (3,61)
17W03351	W 3351	.335 (8,51)	.190 (4,83)	.032 (0,81)
17W03352	W 3352	.335 (8,50)	.255 (6,47)	.150 (3,81)
17W03412	W 3412	.434 (11,02)	.190 (4,83)	1/8 (3,17)
17W03450	W 3450	.345 (8,76)	.218 (5,54)	.032 (0,81)
17W03451	W 3451	.345 (8,76)	.252 (6,40)	.125 (3,17)
17W03480	W 3480	.348 (8,84)	.222 (5,64)	.081 (2,06)
17W03501	W 3501	.350 (8,89)	.240 (6,10)	.040 (1,02)
17W03505	W 3505	.355 (9,02)	.130 (3,30)	.062 (1,57)
17W03506	W 3506	.356 (9,04)	.179 (4,55)	.118 (3,00)
17W03507	W 3507	.350 (8,89)	.190 (4,83)	.062 (1,57)
17W03510	W 3510	.350 (8,89)	.260 (6,60)	.062 (1,57)
17W03540	W 3540	.354 (8,99)	.169 (4,29)	.031 (0,79)
17W03541	W 3541	.353 (8,97)	.197 (5,00)	.157 (3,99)
17W03542	W 3542	.370 (9,40)	.192 (4,88)	.080 (2,03)
17W03543	W 3543	.372 (9,45)	.090 (2,29)	.078 (1,98)
17W03544	W 3544	.375 (9,52)	.227 (5,77)	.065 (1,65)
17W03545	W 3545	.365 (9,27)	.227 (5,76)	.067 (1,70)
17W03546	W 3546	.375 (9,53)	.115 (2,92)	.187 (4,75)
17W03548	W 3548	.378 (9,60)	.193 (4,90)	.076 (1,93)
17W03601	W 3601	.374 (9,50)	.220 (5,59)	.062 (1,57)
17W03602	W 3602	.375 (9,52)	.173 (4,39)	.093 (2,36)
17W03603	W 3603	.375 (9,52)	.225 (5,71)	.089 (2,26)
17W03604	W 3604	.377 (9,53)	.158 (4,01)	.032 (0,81)
17W03630	W 3630	.370 (9,40)	.184 (4,67)	.047 (1,19)
17W03631	W 3631	.366 (9,29)	.222 (5,63)	.110 (2,79)
17W03745	W 3745	.370 (9,40)	.143 (3,63)	.156 (3,96)
17W03746	W 3746	.375 (9,52)	.192 (4,88)	.115 (2,92)
17W03747	W 3747	.370 (9,40)	.320 (8,13)	.093 (2,36)
17W03748	W 3748	.375 (9,52)	.312 (7,92)	.125 (3,17)
17W03749	W 3749	.370 (9,40)	.192 (4,88)	.125 (3,18)
17W03750	W 3750	.375 (9,52)	.150 (3,81)	.030 (0,76)
17W03751	W 3751	.375 (9,52)	.172 (4,37)	.060 (1,52)
17W03752	W 3752	.375 (9,52)	.190 (4,83)	.065 (1,65)
17W03753	W 3753	.380 (9,65)	.131 (3,33)	.093 (2,36)
17W03754	W 3754	.375 (9,52)	.250 (6,35)	.093 (2,36)
17W03755	W 3755	.375 (9,52)	.218 (5,54)	.032 (0,81)

New
SIZES

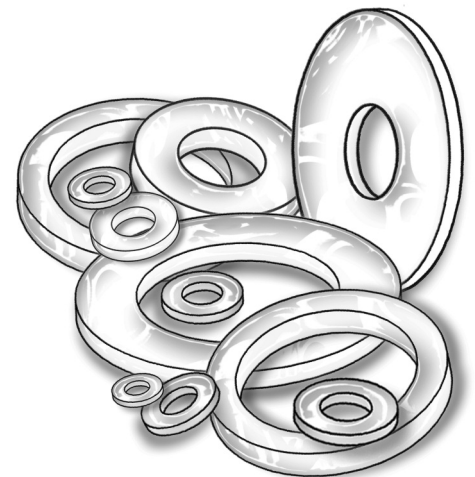
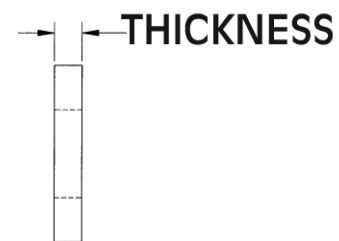
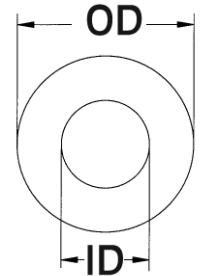

WASHERS, SHOULDER WASHERS & SCREW INSULATORS

SECTION
IV

New
SIZES

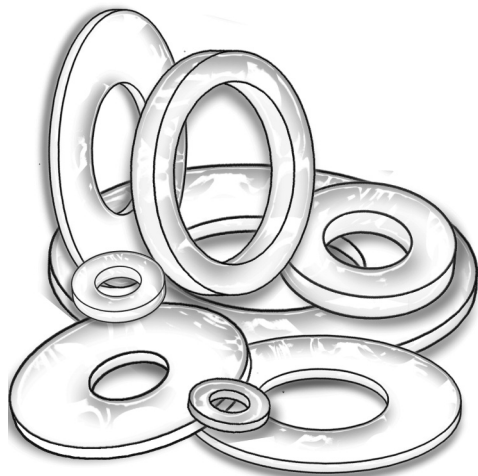
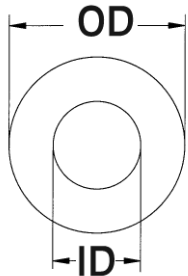

SPECIAL FLAT WASHERS

Molded in Natural Nylon 6/6

ITEM NUMBER	DESCRIPTION	OD	ID	THICKNESS
17W03756	W 3756	.375 (9,52)	.253 (6,43)	.084 (2,13)
17W03757	W 3757	.375 (9,52)	.141 (3,58)	.031 (0,79)
17W03758	W 3758	.375 (9,52)	.125 (3,18)	.040 (1,02)
17W03759	W 3759	.375 (9,52)	.094 (2,39)	.281 (7,14)
17W03760	W 3760	.375 (9,52)	.242 (6,15)	.062 (1,57)
17W03761	W 3761	.375 (9,52)	.210 (5,33)	.160 (4,06)
17W03762	W 3762	.375 (9,52)	.170 (4,32)	.040 (1,02)
17W03763	W 3763	.375 (9,52)	.170 (4,32)	.050 (1,27)
17W03764	W 3764	.375 (9,52)	.189 (4,80)	.031 (0,79)
17W03765	W 3765	.375 (9,52)	.140 (3,56)	.080 (2,03)
17W03766	W 3766	.375 (9,52)	.153 (3,89)	.063 (1,60)
17W03767	W 3767	.377 (9,58)	.221 (5,61)	.095 (2,41)
17W03768	W 3768	.375 (9,52)	.250 (6,35)	.150 (3,81)
17W03769	W 3769	.375 (9,52)	.210 (5,33)	.152 (3,86)
17W03770	W 3770	.375 (9,52)	.130 (3,30)	.030 (0,76)
17W03771	W 3771	.375 (9,52)	.255 (6,48)	.093 (2,36)
17W03772	W 3772	.375 (9,52)	.125 (3,18)	.072 (1,83)
17W03773	W 3773	1.000 (25,40)	.375 (9,53)	.312 (7,92)
17W03775	W 3775	.375 (9,52)	.135 (3,43)	.062 (1,57)
17W03776	W 3776	1.000 (25,40)	3/8" (9,53)	.295 (7,49)
17W03777	W 3777	1.000 (25,40)	.375 (9,52)	.125 (3,17)
17W03801	W 3801	.380 (9,65)	.200 (5,08)	.030 (0,76)
17W03802	W 3802	.380 (9,65)	.187 (4,75)	.155 (3,94)
17W03820	W 3820	.382 (9,70)	.255 (6,48)	.195 (4,95)
17W03900	W 3900	.390 (9,91)	.125 (3,18)	.063 (1,60)
17W03901	W 3901	.390 (9,91)	.200 (5,08)	.031 (0,79)
17W03902	W 3902	.389 (9,88)	.251 (6,37)	.125 (3,17)
17W03903	W 3903	.390 (9,91)	.328 (8,33)	.079 (2,01)
17W03904	W 3904	.400 (10,16)	.140 (3,56)	.062 (1,57)
17W03905	W 3905	.584 (14,83)	.136 (3,45)	.054 (1,37)
17W04000	W 4000	.400 (10,16)	.200 (5,08)	.093 (2,36)
17W04060	W 4060	.405 (10,29)	.265 (6,73)	.125 (3,18)
17W04061	W 4061	.406 (10,31)	.234 (5,94)	.062 (1,57)
17W04062	W 4062	.406 (10,31)	.192 (4,88)	.062 (1,57)
17W04063	W 4063	.406 (10,31)	.266 (6,76)	.080 (2,03)
17W04064	W 4064	.400 (10,16)	.256 (6,50)	.208 (5,28)
17W04065	W 4065	.423 (10,74)	.225 (5,72)	.055 (1,40)
17W04066	W 4066	.421 (10,69)	.291 (7,39)	.090 (2,29)
17W04067	W 4067	.406 (10,31)	.318 (8,07)	.076 (1,93)
17W04068	W 4068	.406 (10,31)	.291 (7,39)	.203 (5,16)
17W04081	W 4081	.408 (10,36)	.177 (4,50)	.062 (1,57)
17W04150	W 4150	.415 (10,54)	.229 (5,82)	.102 (2,59)
17W04160	W 4160	.416 (10,57)	.272 (6,91)	.120 (3,05)
17W04250	W 4250	.425 (10,79)	.235 (5,97)	.130 (3,30)
17W04330	W 4330	.435 (11,05)	.209 (5,31)	.039 (0,99)
17W04331	W 4331	.433 (11,00)	.262 (6,65)	.126 (3,20)
17W04332	W 4332	.433 (11,00)	.275 (6,99)	.075 (1,91)
17W04333	W 4333	.433 (11,00)	.244 (6,20)	.054 (1,37)
17W04334	W 4334	.433 (11,00)	.276 (7,01)	.054 (1,37)
17W04348	W 4348	.435 (11,05)	.241 (6,12)	.094 (2,39)
17W04350	W 4350	.435 (11,05)	.202 (5,13)	.187 (4,75)
17W04351	W 4351	.435 (11,05)	.250 (6,35)	.094 (2,39)
17W04352	W 4352	.435 (11,05)	.196 (4,98)	.046 (1,17)



WASHERS, SHOULDER WASHERS & SCREW INSULATORS

SECTION
IV

SPECIAL FLAT WASHERS

Molded in **Natural Nylon 6/6**

ITEM NUMBER	DESCRIPTION	OD	ID	THICKNESS
17W04353	W 4353	.438 (11,13)	.218 (5,54)	.156 (3,96)
17W04371	W 4371	.437 (11,10)	.200 (5,08)	.062 (1,57)
17W04372	W 4372	.437 (11,10)	.260 (6,60)	.047 (1,19)
17W04373	W 4373	.437 (11,10)	.195 (4,95)	.031 (0,79)
17W04374	W 4374	.437 (11,10)	.200 (5,08)	.115 (2,92)
17W04375	W 4375	.440 (11,18)	.200 (5,08)	.090 (2,29)
17W04376	W 4376	.437 (11,10)	.195 (4,95)	.020 (0,51)
17W04377	W 4377	.437 (11,10)	.195 (4,95)	.040 (1,02)
17W04378	W 4378	.437 (11,10)	.195 (4,95)	.050 (1,27)
17W04379	W 4379	.437 (11,10)	.195 (4,95)	.060 (1,27)
17W04380	W 4380	7/16 (11,10)	11/32 (8,74)	1/16 (1,57)
17W04381	W 4381	.436 (11,07)	.296 (7,52)	.156 (3,96)
17W04386	W 4386	.438 (11,13)	.156 (3,96)	.062 (1,57)
17W04400	W 4400	.440 (11,18)	.156 (3,96)	.032 (0,81)
17W04401	W 4401	.445 (11,30)	.290 (7,37)	.033 (0,84)
17W04402	W 4402	.440 (11,18)	.187 (4,75)	.093 (2,36)
17W04403	W 4403	.440 (11,18)	.318 (8,08)	.031 (0,79)
17W04404	W 4404	.438 (11,13)	.171 (4,34)	.032 (0,81)
17W04405	W 4405	.442 (11,23)	.310 (7,87)	.170 (4,32)
17W04430	W 4430	.443 (11,25)	.253 (6,43)	.125 (3,18)
17W04431	W 4431	7/16 (11,11)	.220 (5,59)	5/16 (7,94)
17W04450	W 4450	.450 (11,43)	.225 (5,72)	.048 (1,22)
17W04451	W 4451	.453 (11,51)	.375 (9,52)	.062 (1,57)
17W04452	W 4452	.453 (11,51)	.280 (7,11)	.030 (0,76)
17W04453	W 4453	7/16 (11,11)	.220 (5,59)	1/2 (12,70)
17W04462	W 4462	7/16 (11,11)	.220 (5,59)	5/8 (15,87)
17W04501	W 4501	.450 (11,43)	.200 (5,08)	.048 (1,22)
17W04502	W 4502	.465 (11,81)	.250 (6,35)	.015 (0,38)
17W04503	W 4503	.450 (11,43)	.200 (5,08)	.030 (0,76)
17W04520	W 4520	.452 (11,48)	.349 (8,86)	.075 (1,91)
17W04601	W 4601	.460 (11,68)	.204 (5,18)	.031 (0,79)
17W04602	W 4602	.472 (11,99)	.209 (5,31)	.108 (2,74)
17W04603	W 4603	.472 (11,99)	.167 (4,24)	.121 (3,07)
17W04604	W 4604	.457 (11,61)	.182 (4,62)	.032 (0,81)
17W04605	W 4605	.470 (11,94)	.093 (2,36)	.250 (6,36)
17W04606	W 4606	.505 (12,82)	.157 (3,98)	.102 (2,59)
17W04650	W 4650	.465 (11,81)	.330 (8,38)	.031 (0,79)
17W04651	W 4651	.486 (12,34)	.252 (6,40)	.069 (1,75)
17W04707	W 4707	.750 (19,05)	.313 (7,95)	.050 (1,25)
17W04708	W 4708	.750 (19,05)	.315 (8,00)	.200 (5,08)
17W04718	W 4718	.472 (11,99)	.252 (6,40)	.032 (0,81)
17W04719	W 4719	.492 (12,50)	.209 (5,31)	.020 (0,51)
17W04720	W 4720	.472 (11,99)	.252 (6,40)	.059 (1,50)
17W04721	W 4721	.505 (12,83)	.375 (9,53)	.050 (1,27)
17W04722	W 4722	.472 (11,99)	.350 (8,89)	.110 (2,79)
17W04725	W 4725	.495 (12,57)	.310 (7,87)	.095 (2,41)
17W04900	W 4900	.490 (12,45)	.136 (3,45)	.055 (1,40)
17W04901	W 4901	.490 (12,45)	.375 (9,53)	.087 (2,21)
17W04950	W 4950	.490 (12,45)	.260 (6,60)	.245 (6,22)
17W04951	W 4951	.500 (12,70)	.205 (5,21)	.125 (3,18)
17W04952	W 4952	.502 (12,72)	.101 (2,57)	.040 (1,02)
17W04953	W 4953	.500 (12,70)	.375 (9,53)	.032 (0,81)
17W04960	W 4960	.500 (12,70)	.225 (5,72)	.032 (0,81)

**New
SIZES**

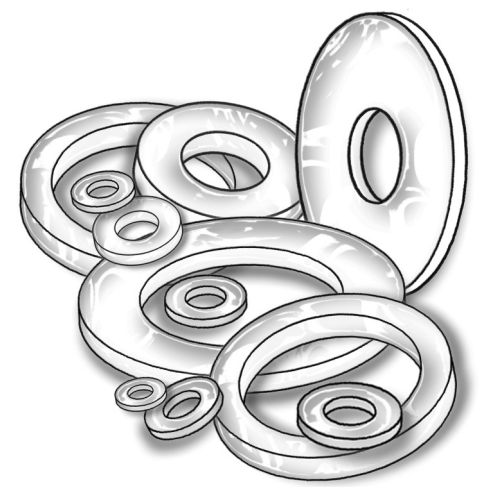
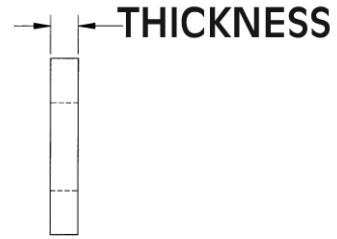
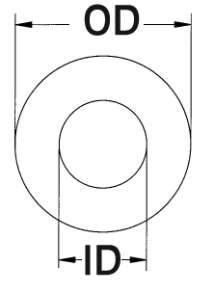

WASHERS, SHOULDER WASHERS & SCREW INSULATORS

SECTION
IV

New
SIZES

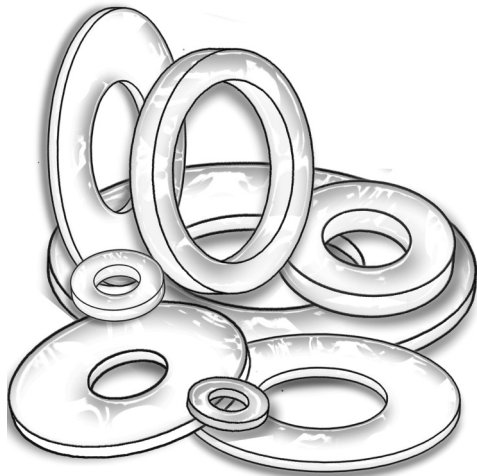
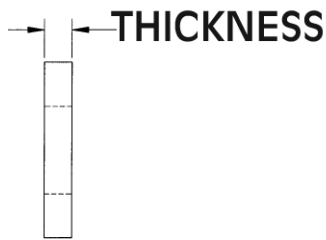
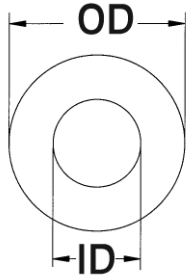

SPECIAL FLAT WASHERS

Molded in Natural Nylon 6/6

ITEM NUMBER	DESCRIPTION	OD	ID	THICKNESS
17W05000	W 5000	.500 (12,70)	.165 (4,19)	.075 (1,91)
17W05001	W 5001	.500 (12,70)	.343 (8,71)	.109 (2,77)
17W05002	W 5002	.500 (12,70)	.385 (9,78)	.160 (4,06)
17W05003	W 5003	.490 (12,45)	.281 (7,14)	.030 (0,76)
17W05004	W 5004	.500 (12,70)	.317 (8,05)	.032 (0,81)
17W05005	W 5005	.500 (12,70)	.375 (9,53)	.087 (2,21)
17W05006	W 5006	.500 (12,70)	.312 (7,92)	.156 (3,96)
17W05007	W 5007	.500 (12,70)	.250 (6,35)	.150 (3,81)
17W05008	W 5008	.505 (12,83)	.188 (4,78)	.032 (0,81)
17W05009	W 5009	.500 (12,70)	.255 (6,48)	.075 (1,91)
17W05010	W 5010	.500 (12,70)	.312 (7,92)	.125 (3,18)
17W05012	W 5012	.50 (12,70)	.125 (3,18)	.125 (3,18)
17W05013	W 5013	.500 (12,70)	.320 (8,13)	.170 (4,32)
17W05014	W 5014	.500 (12,70)	.140 (3,56)	.062 (1,57)
17W05015	W 5015	.500 (12,70)	.144 (3,66)	.125 (3,18)
17W05016	W 5016	.500 (12,70)	.219 (5,54)	.156 (3,90)
17W05017	W 5017	.50 (12,70)	.262 (6,65)	.15 (3,81)
17W05018	W 5018	.500 (12,70)	.187 (4,75)	.062 (1,57)
17W05019	W 5019	.500 (12,70)	.175 (4,45)	.062 (1,57)
17W05020	W 5020	.500 (12,70)	.320 (8,13)	.200 (5,08)
17W05021	W 5021	.505 (12,83)	.138 (3,51)	.080 (2,03)
17W05022	W 5022	.495 (12,57)	.147 (3,73)	.298 (7,57)
17W05023	W 5023	.500 (12,70)	.188 (4,78)	.062 (1,57)
17W05024	W 5024	.497 (12,62)	.321 (8,15)	.060 (1,52)
17W05025	W 5025	.500 (12,70)	.140 (3,56)	.043 (1,09)
17W05027	W 5027	1/2 (12,70)	.320 (8,13)	.250 (6,35)
17W05028	W 5028	.500 (12,70)	.320 (8,13)	.281 (7,14)
17W05029	W 5029	.513 (13,03)	.333 (8,45)	.079 (2,00)
17W05079	W 5079	.500 (12,70)	.317 (8,05)	.092 (2,33)
17W05080	W 5080	.500 (12,70)	.219 (5,56)	.093 (2,36)
17W05081	W 5081	.500 (12,70)	.312 (7,92)	.096 (2,44)
17W05120	W 5120	.510 (12,95)	.193 (4,90)	.050 (1,27)
17W05121	W 5121	.512 (13,00)	.406 (10,31)	.089 (2,26)
17W05122	W 5122	.492 (12,50)	.287 (7,29)	.197 (5,00)
17W05123	W 5123	.512 (13,00)	.405 (10,29)	.054 (1,37)
17W05129	W 5129	.518 (13,16)	.370 (9,40)	.038 (0,97)
17W05230	W 5230	.523 (13,28)	.463 (11,76)	.060 (1,52)
17W05231	W 5231	.538 (13,67)	.272 (6,91)	.047 (1,19)
17W05232	W 5232	.532 (13,51)	.120 (3,05)	.063 (1,60)
17W05251	W 5251	.530 (13,46)	.375 (9,53)	.093 (2,36)
17W05252	W 5252	.528 (13,41)	.402 (10,21)	.039 (0,99)
17W05253	W 5253	.525 (13,34)	.475 (12,07)	.070 (1,78)
17W05254	W 5254	.525 (13,34)	.194 (4,93)	.032 (0,81)
17W05255	W 5255	.1.375 (34,93)	.515 (13,08)	.093 (2,36)
17W05310	W 5310	.531 (13,49)	.315 (8,00)	.031 (0,79)
17W05400	W 5400	.540 (13,72)	.405 (10,29)	.112 (2,84)
17W05401	W 5401	.540 (13,72)	.382 (9,70)	.096 (2,44)
17W05421	W 5421	.542 (13,77)	.388 (9,86)	.220 (5,59)
17W05422	W 5422	.542 (13,77)	.404 (10,26)	.097 (2,46)
17W05423	W 5423	.542 (13,77)	.404 (10,26)	.110 (2,79)
17W05424	W 5424	.540 (13,72)	.405 (10,29)	.080 (2,03)
17W05451	W 5451	.555 (14,10)	.363 (9,22)	.062 (1,57)
17W05461	W 5461	.554 (14,07)	.481 (12,22)	.030 (0,76)



WASHERS, SHOULDER WASHERS & SCREW INSULATORS

SECTION
IV

SPECIAL FLAT WASHERS

Molded in Natural Nylon 6/6

ITEM NUMBER	DESCRIPTION	OD	ID	THICKNESS
17W05510	W 5510	.551 (14,00)	.378 (9,60)	.063 (1,60)
17W05512	W 5512	.550 (13,97)	.386 (9,80)	.060 (1,52)
17W05552	W 5552	.555 (14,10)	.255 (6,48)	.047 (1,19)
17W05553	W 5553	.555 (14,10)	.415 (10,54)	.060 (1,52)
17W05601	W 5601	.560 (14,22)	.265 (6,73)	.030 (0,76)
17W05602	W 5602	.560 (14,22)	.260 (6,60)	.125 (3,18)
17W05603	W 5603	.560 (14,22)	.320 (8,13)	.187 (4,75)
17W05604	W 5604	.531 (13,49)	.265 (6,73)	.062 (1,57)
17W05605	W 5605	.560 (14,22)	.373 (9,47)	.031 (0,79)
17W05606	W 5606	.562 (14,27)	.265 (6,73)	.187 (4,75)
17W05607	W 5607	.560 (14,22)	.290 (7,37)	.062 (1,57)
17W05608	W 5608	.560 (14,22)	.315 (8,00)	.062 (1,57)
17W05609	W 5609	.562 (14,27)	.312 (7,92)	.031 (0,79)
17W05620	W 5620	.562 (14,27)	.141 (3,58)	.062 (1,57)
17W05621	W 5621	.562 (14,27)	.250 (6,35)	.031 (0,79)
17W05622	W 5622	.562 (14,27)	.260 (6,60)	.062 (1,57)
17W05623	W 5623	.565 (14,35)	.203 (5,16)	.062 (1,57)
17W05624	W 5624	.562 (14,27)	.320 (8,13)	.020 (0,51)
17W05625	W 5625	.562 (14,27)	.260 (6,60)	.113 (2,87)
17W05626	W 5626	.562 (14,27)	.256 (6,50)	.250 (6,35)
17W05629	W 5629	.562 (14,27)	.328 (8,33)	.095 (2,41)
17W05630	W 5630	.565 (14,35)	.317 (8,05)	.095 (2,41)
17W05631	W 5631	.568 (14,43)	.253 (6,43)	.093 (2,36)
17W05632	W 5632	.563 (14,30)	.468 (11,89)	.155 (3,94)
17W05633	W 5633	.563 (14,30)	.316 (8,02)	.035 (0,88)
17W05650	W 5650	.565 (14,35)	.254 (6,45)	.094 (2,39)
17W05700	W 5700	37/64 (14,68)	.307 (7,80)	1/8 (3,18)
17W05701	W 5701	.575 (14,61)	.299 (7,59)	.039 (0,99)
17W05751	W 5751	.575 (14,61)	.467 (11,86)	.090 (2,29)
17W05910	W 5910	.591 (15,01)	.256 (6,50)	.087 (2,21)
17W05911	W 5911	.591 (15,01)	.265 (6,73)	.101 (2,56)
17W05980	W 5980	.598 (15,19)	.396 (10,03)	.175 (4,45)
17W05981	W 5981	.562 (14,27)	.320 (8,13)	.125 (3,18)
17W05982	W 5982	.590 (14,99)	.328 (8,33)	.147 (3,73)
17W05983	W 5983	.591 (15,01)	.374 (9,50)	.118 (3,00)
17W05984	W 5984	.600 (15,24)	.423 (10,74)	.032 (0,81)
17W05985	W 5985	.578 (14,68)	.395 (10,03)	.062 (1,57)
17W06001	W 6001	.600 (15,24)	.500 (12,70)	.120 (3,05)
17W06101	W 6101	.615 (15,62)	.406 (10,31)	.042 (1,07)
17W06140	W 6140	.614 (15,60)	.464 (11,79)	.110 (2,79)
17W06150	W 6150	.615 (15,62)	.260 (6,60)	.100 (2,54)
17W06151	W 6151	.625 (15,88)	.500 (12,70)	.132 (3,35)
17W06152	W 6152	.615 (15,62)	.340 (8,64)	.125 (3,18)
17W06153	W 6153	.625 (15,88)	.406 (10,31)	.120 (3,05)
17W06154	W 6154	.753 (19,13)	.605 (15,37)	.067 (1,70)
17W06155	W 6155	.615 (15,62)	.380 (9,65)	.122 (3,10)
17W06201	W 6201	.620 (15,75)	.265 (6,73)	.192 (4,89)
17W06203	W 6203	.620 (15,75)	.209 (5,31)	.180 (4,57)
17W06204	W 6204	.620 (15,75)	.350 (8,89)	.188 (4,78)
17W06205	W 6205	.625 (15,88)	.410 (10,41)	.033 (0,83)
17W06206	W 6206	.625 (15,88)	.260 (6,60)	.140 (3,56)
17W06221	W 6221	.622 (15,80)	.252 (6,40)	.060 (1,52)
17W06222	W 6222	.625 (15,88)	.250 (6,35)	.190 (4,83)

New
SIZES

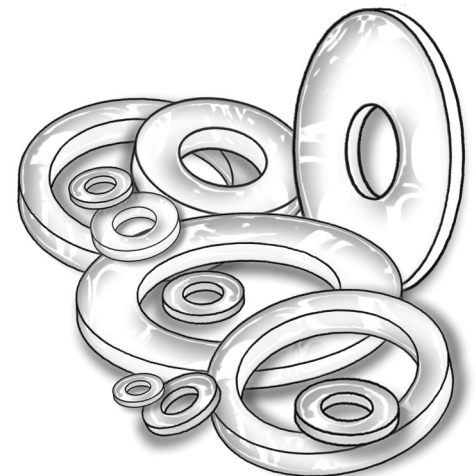
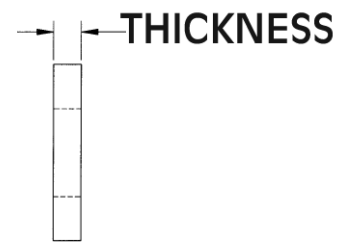
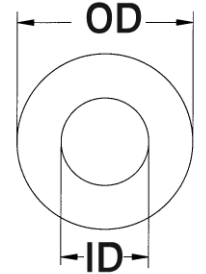

WASHERS, SHOULDER WASHERS & SCREW INSULATORS

SECTION
IV

New
SIZES

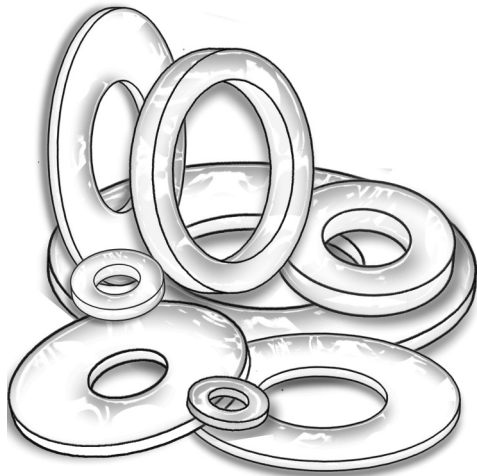
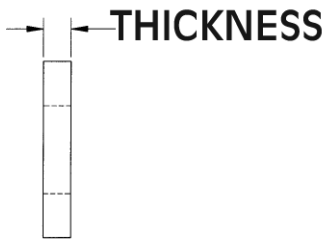
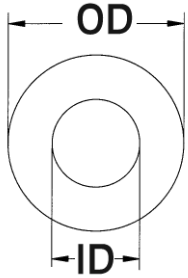

SPECIAL FLAT WASHERS

Molded in Natural Nylon 6/6

ITEM NUMBER	DESCRIPTION	OD		ID		THICKNESS	
17W06240	W 6240	.625	(15,88)	.505	(12,83)	.092	(2,34)
17W06248	W 6248	.625	(15,88)	.330	(8,38)	.064	(1,63)
17W06249	W 6249	.625	(15,88)	.260	(6,60)	.180	(4,57)
17W06250	W 6250	.620	(15,75)	.165	(4,19)	.250	(6,35)
17W06251*	W 6251	.620	(15,87)	.301	(7,64)	.039	(0,99)
17W06252	W 6252	.625	(15,88)	.194	(4,93)	.125	(3,18)
17W06253	W 6253	.625	(15,88)	.187	(4,75)	.062	(1,57)
17W06254	W 6254	.625	(15,88)	.218	(5,54)	.062	(1,57)
17W06255	W 6255	.625	(15,88)	.250	(6,35)	.062	(1,57)
17W06256	W 6256	.625	(15,88)	.437	(11,10)	.093	(2,36)
17W06257	W 6257	.625	(15,88)	.125	(3,18)	.062	(1,57)
17W06258	W 6258	.625	(15,88)	.218	(5,54)	.125	(3,18)
17W06259	W 6259	.625	(15,88)	.218	(5,54)	.500	(12,70)
17W06260	W 6260	.625	(15,88)	.218	(5,54)	.250	(6,35)
17W06261	W 6261	.625	(15,88)	.390	(9,91)	.265	(6,73)
17W06262	W 6262	.625	(15,88)	.257	(6,53)	.020	(0,51)
17W06263	W 6263	.625	(15,88)	.281	(7,14)	.110	(2,79)
17W06264	W 6264	.625	(15,88)	.315	(8,00)	.031	(0,79)
17W06265	W 6265	.625	(15,88)	.422	(10,72)	.203	(5,16)
17W06266	W 6266	.625	(15,88)	.321	(8,15)	.125	(3,18)
17W06267	W 6267	.625	(15,88)	.218	(5,54)	.031	(0,79)
17W06268	W 6268	.625	(15,88)	.437	(11,10)	.250	(6,35)
17W06269	W 6269	5/8	(15,87)	.281	(7,14)	.210	(5,33)
17W06270	W 6270	.618	(15,70)	.270	(6,86)	.220	(5,59)
17W06271	W 6271	.630	(16,00)	.327	(8,31)	.071	(1,80)
17W06272	W 6272	.625	(15,88)	.385	(9,78)	.185	(4,70)
17W06273	W 6273	.625	(15,88)	.312	(7,92)	.250	(6,35)
17W06274	W 6274	.625	(15,88)	.284	(7,21)	.062	(1,57)
17W06275	W 6275	.625	(15,88)	.292	(7,42)	.040	(1,02)
17W06276	W 6276	.630	(16,00)	.355	(9,02)	.040	(1,02)
17W06277	W 6277	.625	(15,87)	.380	(9,65)	.050	(1,27)
17W06278	W 6278	.625	(15,87)	.320	(8,12)	.125	(3,17)
17W06289	W 6289	.625	(15,88)	.265	(6,73)	.093	(2,36)
17W06302	W 6302	.630	(16,00)	.171	(4,34)	.060	(1,52)
17W06303	W 6303	.638	(16,20)	.283	(7,19)	.077	(1,96)
17W06304	W 6304	.629	(15,98)	.437	(11,10)	.125	(3,18)
17W06305	W 6305	.630	(16,00)	.165	(4,19)	.118	(3,00)
17W06306	W 6306	.626	(15,90)	.182	(4,62)	.045	(1,14)
17W06310	W 6310	.630	(16,00)	.280	(7,11)	.030	(0,76)
17W06311	W 6311	.625	(15,87)	.260	(6,60)	.031	(0,78)
17W06365	W 6365	.636	(16,15)	.526	(13,36)	.098	(2,49)
17W06439	W 6439	.643	(16,33)	.510	(12,95)	.090	(2,29)
17W06440	W 6440	1.122	(28,50)	.644	(16,36)	.217	(5,51)
17W06470	W 6470	.647	(16,43)	.216	(5,48)	.031	(0,78)
17W06500	W 6500	.650	(16,51)	.440	(11,18)	.125	(3,18)
17W06501	W 6501	1.190	(30,23)	.650	(16,51)	.090	(2,29)
17W06591	W 6591	.659	(16,74)	.468	(11,89)	.119	(3,02)
17W06592	W 6592	.656	(16,66)	.433	(10,99)	.085	(2,15)
17W06593	W 6593	.670	(17,01)	.250	(6,35)	.098	(2,48)
17W06620	W 6620	.662	(16,81)	.440	(11,18)	.122	(3,10)
17W06701	W 6701	.670	(17,02)	.448	(11,38)	.120	(3,05)
17W06711	W 6711	.671	(17,04)	.481	(12,22)	.031	(0,79)
17W06712	W 6712	.670	(17,02)	.217	(5,51)	.050	(1,27)

* ID IS CHAMFERED



WASHERS, SHOULDER WASHERS & SCREW INSULATORS

SECTION
IV

SPECIAL FLAT WASHERS

Molded in Natural Nylon 6/6

ITEM NUMBER	DESCRIPTION	OD	ID	THICKNESS
17W06713	W 6713	.669 (16,99)	.323 (8,20)	.039 (0,99)
17W06820	W 6820	.682 (17,32)	.170 (4,32)	.062 (1,57)
17W06830	W 6830	.683 (17,35)	.337 (8,56)	.063 (1,60)
17W06851	W 6851	.685 (17,40)	.260 (6,60)	.032 (0,81)
17W06855	W 6855	.685 (17,40)	.295 (7,49)	.062 (1,57)
17W06856	W 6856	.695 (17,65)	.388 (9,85)	.059 (1,50)
17W06866	W 6866	.687 (17,45)	.260 (6,60)	.125 (3,18)
17W06867	W 6867	.687 (17,45)	.343 (8,71)	.031 (0,79)
17W06868	W 6868	.687 (17,45)	.260 (6,60)	.020 (0,51)
17W06869	W 6869	.687 (17,45)	.260 (6,60)	.050 (1,27)
17W06870	W 6870	.687 (17,45)	.344 (8,79)	.064 (1,63)
17W06871	W 6871	.687 (17,45)	.260 (6,60)	.060 (1,52)
17W06872	W 6872	.687 (17,45)	.260 (6,60)	.040 (1,02)
17W06873	W 6873	.687 (17,45)	.421 (10,69)	.031 (0,79)
17W06874	W 6874	.687 (17,45)	.421 (10,69)	.062 (1,57)
17W06875	W 6875	.692 (17,58)	.507 (12,88)	.042 (1,07)
17W06876	W 6876	.687 (17,45)	.568 (14,43)	.062 (1,57)
17W06877	W 6877	.680 (17,27)	.390 (9,91)	.125 (3,18)
17W06878	W 6878	.687 (17,45)	.156 (3,96)	.135 (3,43)
17W06879	W 6879	.687 (17,45)	.280 (7,11)	.031 (0,79)
17W06880	W 6880	.680 (17,27)	.318 (8,08)	.187 (4,75)
17W06881	W 6881	.688 (17,48)	.390 (9,91)	.031 (0,79)
17W06882	W 6882	.688 (17,48)	.318 (8,08)	.190 (4,83)
17W06883	W 6883	.689 (17,50)	.244 (6,20)	.236 (5,99)
17W06884	W 6884	.688 (17,48)	.434 (11,02)	.125 (3,17)
17W06934	W 6934	.695 (17,65)	.082 (2,08)	.184 (4,67)
17W06935	W 6935	.690 (17,53)	.525 (13,34)	.250 (6,35)
17W07001	W 7001	.700 (17,78)	.565 (14,35)	.062 (1,57)
17W07002	W 7002	.700 (17,78)	.531 (13,49)	.093 (2,36)
17W07051	W 7051	.715 (18,16)	.570 (14,48)	.100 (2,54)
17W07090	W 7090	.709 (18,01)	.336 (8,53)	.079 (2,01)
17W07091	W 7091	.709 (18,01)	.461 (11,71)	.110 (2,79)
17W07092	W 7092	.697 (17,70)	.531 (13,49)	.158 (4,01)
17W07093	W 7093	.71 (18,03)	.49 (12,45)	.125 (3,17)
17W07094	W 7094	.700 (17,78)	.548 (13,91)	.080 (2,03)
17W07095	W 7095	.710 (18,03)	.313 (7,95)	.050 (1,27)
17W07096	W 7096	.697 (17,70)	.531 (13,49)	.167 (4,24)
17W07120	W 7120	.712 (18,08)	.522 (13,30)	.062 (1,57)
17W07121	W 7121	.712 (18,08)	.312 (7,92)	.081 (2,06)
17W07130	W 7130	.713 (18,11)	.463 (11,76)	.065 (1,65)
17W07181	W 7181	.718 (18,24)	.526 (13,36)	.219 (5,56)
17W07182	W 7182	.718 (18,24)	.526 (13,36)	.281 (7,14)
17W07183	W 7183	.725 (18,41)	.500 (12,70)	.110 (2,79)
17W07184	W 7184	.750 (19,05)	.594 (15,09)	.210 (5,33)
17W07191	W 7191	.719 (18,26)	.250 (6,35)	.062 (1,57)
17W07192	W 7192	.719 (18,26)	.281 (7,14)	.062 (1,57)
17W07193	W 7193	.709 (18,00)	.248 (6,10)	.118 (3,00)
17W07194	W 7194	.709 (18,00)	.209 (5,30)	.039 (0,99)
17W07301	W 7301	.720 (18,29)	.390 (9,91)	.300 (7,62)
17W07302	W 7302	.731 (18,57)	.266 (6,76)	.118 (3,00)
17W07381	W 7381	.740 (18,80)	.220 (5,59)	.120 (3,05)
17W07382	W 7382	.738 (18,75)	.522 (13,26)	.120 (3,05)
17W07401	W 7401	.740 (18,80)	.340 (8,64)	.062 (1,57)

New
SIZES

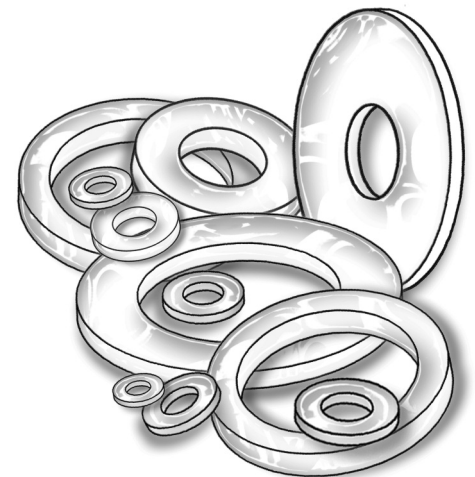
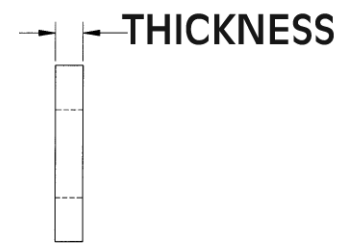
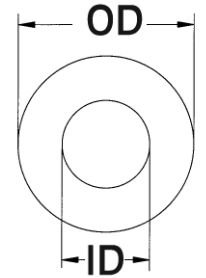

WASHERS, SHOULDER WASHERS & SCREW INSULATORS

SECTION IV

New SIZES

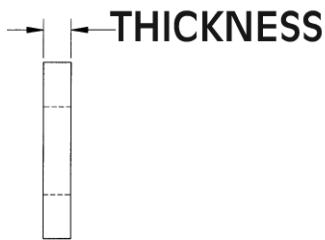
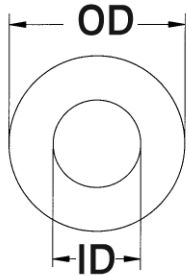

SPECIAL FLAT WASHERS

Molded in Natural Nylon 6/6

ITEM NUMBER	DESCRIPTION	OD	ID	THICKNESS
17W07402	W 7402	.750 (19,05)	.375 (9,53)	.062 (1,57)
17W07403	W 7403	.748 (19,00)	.395 (10,03)	.093 (2,36)
17W07404	W 7404	.750 (19,05)	.440 (11,18)	.093 (2,36)
17W07405	W 7405	.750 (19,05)	.385 (9,78)	.045 (1,14)
17W07406	W 7406	.740 (18,80)	.516 (13,11)	.125 (3,18)
17W07407	W 7407	.750 (19,05)	.375 (9,53)	.250 (6,35)
17W07408	W 7408	.750 (19,05)	.330 (8,38)	.062 (1,57)
17W07409	W 7409	.754 (19,15)	.394 (10,01)	.255 (6,48)
17W07420	W 7420	.742 (18,85)	.498 (12,65)	.119 (3,02)
17W07450	W 7450	.745 (18,92)	.570 (14,48)	.031 (0,79)
17W07480	W 7480	.748 (19,00)	.403 (10,24)	.059 (1,50)
17W07491	W 7491	.750 (19,05)	.191 (4,85)	.100 (2,54)
17W07492	W 7492	.996 (25,30)	.201 (5,11)	.200 (5,08)
17W07493	W 7493	.738 (18,75)	.220 (5,59)	.160 (4,06)
17W07494	W 7494	.750 (19,05)	.257 (6,53)	.030 (0,76)
17W07495	W 7495	.748 (19,00)	.203 (5,16)	.200 (5,08)
17W07496	W 7496	1.000 (25,40)	.215 (5,46)	.062 (1,57)
17W07500	W 7500	.750 (19,05)	.261 (6,63)	.095 (2,41)
17W07501	W 7501	.750 (19,05)	.187 (4,75)	.156 (3,96)
17W07502	W 7502	.735 (18,67)	.360 (9,14)	.160 (4,06)
17W07503	W 7503	.750 (19,05)	.323 (8,20)	.125 (3,18)
17W07504	W 7504	.738 (18,75)	.382 (9,70)	.160 (4,06)
17W07505	W 7505	.740 (18,79)	.531 (13,49)	.187 (4,75)
17W07506	W 7506	.750 (19,05)	.390 (9,91)	.062 (1,57)
17W07507	W 7507	.750 (19,05)	.352 (8,94)	.031 (0,79)
17W07508	W 7508	.750 (19,05)	.390 (9,91)	.050 (1,27)
17W07509	W 7509	.750 (19,05)	.390 (9,91)	.140 (3,56)
17W07510	W 7510	.750 (19,05)	.530 (13,46)	.230 (5,84)
17W07511	W 7511	.750 (19,05)	.625 (15,88)	.170 (4,32)
17W07512	W 7512	.750 (19,05)	.385 (9,78)	.200 (5,08)
17W07513	W 7513	.750 (19,05)	.317 (8,05)	.062 (1,57)
17W07514	W 7514	.750 (19,05)	.193 (4,90)	.040 (1,02)
17W07516	W 7516	.750 (19,05)	.382 (9,70)	.066 (1,68)
17W07517	W 7517	.750 (19,05)	.406 (10,31)	.032 (0,81)
17W07518	W 7518	.745 (18,92)	.443 (11,25)	.095 (2,41)
17W07519	W 7519	.750 (19,05)	.218 (5,54)	.187 (4,75)
17W07520	W 7520	.745 (18,92)	.260 (6,60)	.066 (1,68)
17W07521	W 7521	.750 (19,05)	.320 (8,13)	.250 (6,35)
17W07522	W 7522	.750 (19,05)	.406 (10,31)	.060 (1,52)
17W07523	W 7523	.745 (18,92)	.260 (6,60)	.125 (3,18)
17W07524	W 7524	.743 (18,87)	.516 (13,11)	.093 (2,36)
17W07525	W 7525	.750 (19,05)	.406 (10,31)	.200 (5,08)
17W07527	W 7527	.750 (19,05)	.375 (9,53)	.125 (3,18)
17W07528	W 7528	.750 (19,05)	.385 (9,78)	.025 (0,63)
17W07529	W 7529	.75 (19,05)	.31 (7,87)	.375 (9,53)
17W07530	W 7530	.750 (19,05)	.257 (6,53)	.062 (1,57)
17W07531	W 7531	.755 (19,18)	.558 (14,17)	.030 (0,76)
17W07532	W 7532	.750 (19,05)	.150 (3,81)	.055 (1,40)
17W07533	W 7533	.750 (19,05)	.47 (11,94)	.200 (5,08)
17W07534	W 7534	.685 (17,40)	.473 (12,01)	.190 (4,83)
17W07535	W 7535	.75 (19,05)	.30 (7,62)	.125 (3,17)
17W07536	W 7536	.754 (19,15)	.389 (9,88)	.075 (1,91)
17W07537	W 7537	.750 (19,05)	.437 (11,10)	.036 (0,91)



WASHERS, SHOULDER WASHERS & SCREW INSULATORS

SECTION
IV

SPECIAL FLAT WASHERS

Molded in Natural Nylon 6/6

ITEM NUMBER	DESCRIPTION	OD	ID	THICKNESS
17W07539	W 7539	.962 (24,43)	.755 (19,18)	.101 (2,57)
17W07540	W 7540	.753 (19,13)	.605 (15,37)	.055 (1,40)
17W07541	W 7541	3/4" (19,05)	.257 (6,53)	.109 (2,77)
17W07542	W 7542	.755 (19,18)	.318 (8,08)	.100 (2,54)
17W07543	W 7543	.750 (19,05)	.266 (6,76)	.155 (3,94)
17W07559	W 7559	.750 (19,05)	.380 (9,65)	.187 (4,75)
17W07560	W 7560	.756 (19,20)	.578 (14,68)	.110 (2,79)
17W07561	W 7561	.744 (18,90)	.541 (13,74)	.075 (1,91)
17W07564	W 7564	.728 (18,49)	.513 (13,03)	.072 (1,83)
17W07565	W 7565	.745 (18,92)	.509 (12,93)	.150 (3,81)
17W07566	W 7566	.750 (19,05)	.310 (7,87)	.170 (4,32)
17W07625	W 7625	.75 (19,05)	.274 (6,96)	.25 (6,35)
17W07626	W 7626	.750 (19,05)	.335 (8,51)	.250 (6,35)
17W07714	W 7714	3/4" (19,05)	.317 (8,05)	.040 (1,02)
17W07716	W 7716	.750 (19,05)	.296 (7,52)	.032 (0,81)
17W07717	W 7717	.750 (19,05)	.328 (8,33)	.032 (0,81)
17W07718	W 7718	.757 (19,23)	.394 (10,01)	.125 (3,18)
17W07719	W 7719	.748 (19,00)	.400 (10,16)	.089 (2,26)
17W07720	W 7720	.753 (19,13)	.282 (7,16)	.123 (3,12)
17W07721	W 7721	.740 (18,80)	.215 (5,46)	.095 (2,41)
17W07722	W 7722	.750 (19,05)	.565 (14,35)	.125 (3,18)
17W07750	W 7750	.775 (19,69)	.515 (13,08)	.250 (6,35)
17W07751	W 7751	.775 (19,69)	.500 (12,70)	.120 (3,05)
17W07752	W 7752	.775 (19,69)	.485 (12,32)	.150 (3,81)
17W07811	W 7811	.781 (19,84)	.640 (16,26)	.031 (0,79)
17W07820	W 7820	.782 (19,86)	.633 (16,08)	.125 (3,18)
17W07821	W 7821	.778 (19,76)	.590 (14,99)	.032 (0,81)
17W07850	W 7850	.785 (19,94)	.394 (10,01)	.080 (2,03)
17W07851	W 7851	.787 (19,98)	.409 (10,39)	.236 (5,99)
17W07852	W 7852	.787 (19,98)	.276 (7,01)	.197 (5,00)
17W07853	W 7853	.787 (19,98)	.279 (7,08)	.138 (3,50)
17W08049	W 8049	.805 (20,45)	.418 (10,62)	.062 (1,57)
17W08050	W 8050	.805 (20,45)	.510 (12,95)	.220 (5,59)
17W08051	W 8051	.805 (20,45)	.621 (15,77)	.125 (3,18)
17W08070	W 8070	.807 (20,50)	.402 (10,21)	.065 (1,65)
17W08090	W 8090	.809 (20,55)	.495 (12,57)	.059 (1,50)
17W08100	W 8100	.810 (20,57)	.435 (11,05)	.060 (1,52)
17W08110	W 8110	.817 (20,75)	.544 (13,82)	.140 (3,56)
17W08121	W 8121	.812 (20,67)	.695 (17,65)	.093 (2,36)
17W08122	W 8122	.812 (20,62)	.630 (16,00)	.100 (2,56)
17W08123	W 8123	.812 (20,62)	.312 (7,92)	.125 (3,18)
17W08125	W 8125	.812 (20,62)	.630 (16,00)	.220 (5,59)
17W08126	W 8126	.812 (20,62)	.386 (9,80)	.187 (4,75)
17W08129	W 8129	.812 (20,62)	.625 (15,88)	.062 (1,57)
17W08130	W 8130	.812 (20,62)	.312 (7,92)	.062 (1,57)
17W08251	W 8251	.825 (20,96)	.480 (12,19)	.100 (2,54)
17W08252	W 8252	.825 (20,96)	.561 (14,25)	.145 (3,68)
17W08253	W 8253	.825 (20,96)	.640 (16,26)	.040 (1,02)
17W08400	W 8400	.840 (21,34)	.730 (18,54)	.125 (3,18)
17W08430	W 8430	.844 (21,44)	.656 (16,66)	.060 (1,52)
17W08431	W 8431	.845 (21,46)	.621 (15,77)	.101 (2,57)
17W08452	W 8452	.825 (20,96)	.375 (9,53)	.100 (2,54)
17W08650	W 8650	.865 (21,97)	.531 (13,49)	.200 (5,08)

New
SIZES

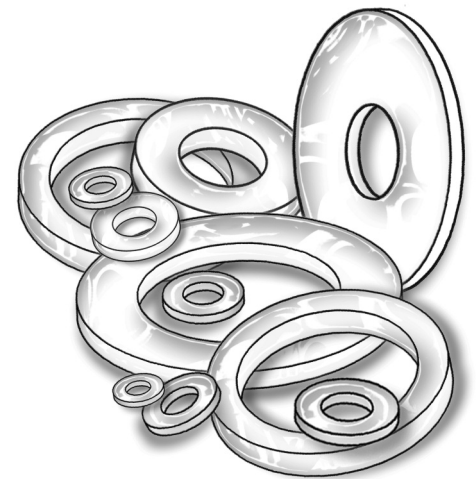
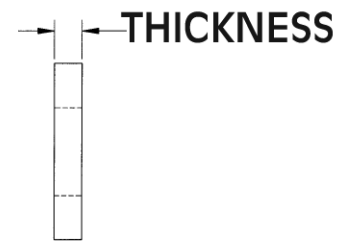
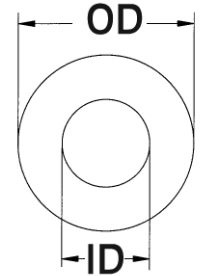

WASHERS, SHOULDER WASHERS & SCREW INSULATORS

SECTION
IV

SPECIAL FLAT WASHERS

Molded in Natural Nylon 6/6

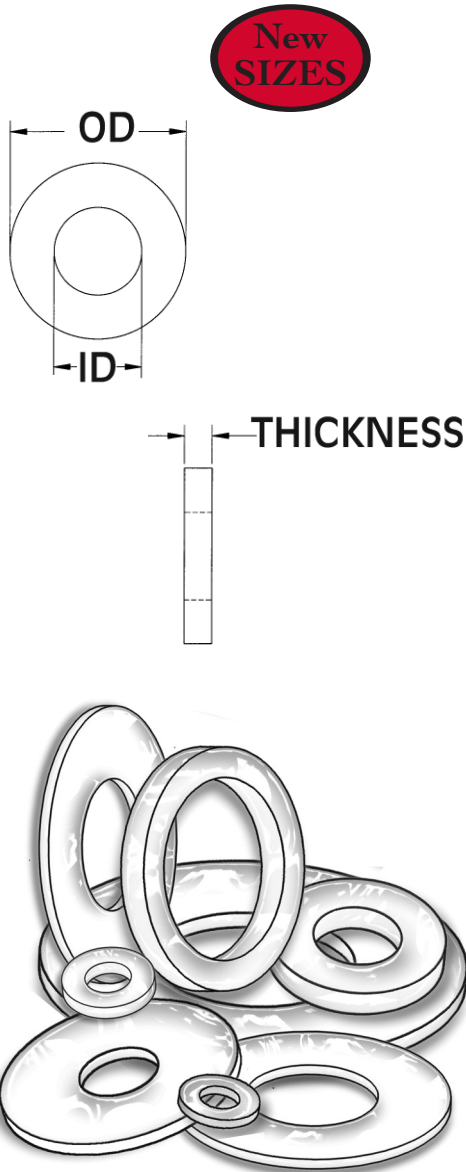

ITEM NUMBER	DESCRIPTION	OD	ID	THICKNESS
17W08651	W 8651	.865 (21,97)	.688 (17,48)	.155 (3,94)
17W08652	W 8652	.875 (22,23)	.755 (19,18)	.125 (3,18)
17W08653	W 8653	.862 (21,89)	.690 (17,53)	.220 (5,59)
17W08660	W 8660	.866 (21,97)	.413 (10,49)	.098 (2,49)
17W08661	W 8661	.876 (22,25)	.437 (11,10)	.502 (12,75)
17W08710	W 8710	.887 (22,52)	.797 (20,24)	.500 (12,70)
17W08711	W 8711	.871 (22,12)	.706 (17,93)	.111 (2,82)
17W08747	W 8747	.875 (22,22)	.532 (13,51)	.155 (3,93)
17W08748	W 8748	.878 (22,30)	.564 (14,33)	.062 (1,59)
17W08749	W 8749	.870 (22,10)	.506 (12,85)	.201 (5,11)
17W08751	W 8751	.875 (22,23)	.312 (7,92)	.125 (3,18)
17W08752	W 8752	.875 (22,23)	.408 (10,36)	.060 (1,52)
17W08753	W 8753	.875 (22,23)	.257 (6,53)	.031 (0,79)
17W08754	W 8754	.885 (22,48)	.343 (8,71)	.062 (1,57)
17W08755	W 8755	.855 (21,72)	.312 (7,92)	.125 (3,18)
17W08756	W 8756	.875 (22,23)	.500 (12,70)	.125 (3,18)
17W08757	W 8757	.875 (22,23)	.312 (7,92)	.187 (4,75)
17W08758	W 8758	.865 (21,97)	.340 (8,64)	.187 (4,75)
17W08759	W 8759	.875 (22,23)	.377 (9,58)	.062 (1,57)
17W08760	W 8760	.875 (22,23)	.380 (9,65)	.093 (2,36)
17W08761	W 8761	.875 (22,23)	.390 (9,91)	.093 (2,36)
17W08762	W 8762	.875 (22,23)	.257 (6,53)	.062 (1,57)
17W08763	W 8763	.875 (22,23)	.627 (15,93)	.114 (2,90)
17W08764	W 8764	.718 (22,23)	.265 (6,73)	.093 (2,36)
17W08765	W 8765	.870 (22,10)	.531 (13,49)	.187 (4,75)
17W08767	W 8767	.860 (21,84)	.397 (10,08)	.165 (4,19)
17W08768	W 8768	.885 (22,48)	.390 (9,91)	.094 (2,39)
17W08769	W 8769	.875 (22,23)	.750 (19,05)	.160 (4,06)
17W08770	W 8770	.891 (22,63)	.780 (19,81)	.505 (12,83)
17W08771	W 8771	.875 (22,23)	.593 (15,08)	.145 (3,68)
17W08800	W 8800	.880 (22,35)	.390 (9,91)	.062 (1,57)
17W08801	W 8801	.872 (22,15)	.315 (8,00)	.062 (1,57)
17W08802	W 8802	.880 (22,35)	.485 (12,31)	.060 (1,52)
17W08803	W 8803	.882 (22,40)	.589 (14,96)	.085 (2,16)
17W08805	W 8805	.880 (22,35)	.690 (17,52)	.032 (0,81)
17W08806	W 8806	.885 (22,48)	.385 (9,78)	.062 (1,57)
17W08810	W 8810	.880 (22,35)	.500 (12,70)	.065 (1,65)
17W08812	W 8812	.880 (22,86)	.385 (9,78)	.125 (3,18)
17W08813	W 8813	.880 (22,35)	.327 (8,31)	.060 (1,52)
17W08901	W 8901	.890 (22,61)	.315 (8,00)	.215 (5,46)
17W08950	W 8950	.900 (22,86)	.255 (6,48)	.125 (3,18)
17W08951	W 8951	.890 (22,61)	.317 (8,05)	.245 (6,22)
17W08952	W 8952	.902 (22,91)	.244 (6,20)	.079 (2,01)
17W08953	W 8953	.900 (22,86)	.579 (14,71)	.075 (1,91)
17W08954	W 8954	.890 (22,60)	.400 (10,16)	.063 (1,60)
17W09000	W 9000	.900 (22,86)	.375 (9,53)	.055 (1,40)
17W09001	W 9001	.900 (22,86)	.500 (12,70)	.075 (1,91)
17W09002	W 9002	.900 (22,86)	.515 (13,08)	.060 (1,52)
17W09260	W 9260	.926 (23,52)	.705 (17,91)	.124 (3,15)
17W09282	W 9282	.970 (24,64)	.230 (5,84)	.125 (3,18)
17W09283	W 9283	1.005 (25,53)	.406 (10,31)	.080 (2,03)
17W09290	W 9290	.929 (23,60)	.472 (11,99)	.126 (3,20)
17W09320	W 9320	.932 (23,67)	.381 (9,68)	.031 (0,79)



WASHERS, SHOULDER WASHERS & SCREW INSULATORS

SECTION
IV

SPECIAL FLAT WASHERS

Molded in Natural Nylon 6/6

ITEM NUMBER	DESCRIPTION	OD	ID	THICKNESS
17W09350	W 9350	15/16 (23,81)	.380 (9,65)	.062 (1,57)
17W09371	W 9371	.937 (23,80)	.625 (15,88)	.093 (2,36)
17W09376	W 9376	.937 (23,80)	.583 (14,81)	.062 (1,57)
17W09378	W 9378	.937 (23,80)	.580 (14,73)	.082 (2,08)
17W09381	W 9381	.938 (23,83)	.453 (11,51)	.155 (3,94)
17W09400	W 9400	.944 (23,98)	.331 (8,41)	.098 (2,49)
17W09401	W 9401	.945 (24,00)	.354 (9,00)	.157 (4,00)
17W09406	W 9406	.940 (23,88)	.506 (12,85)	.064 (1,63)
17W09571	W 9571	.957 (24,31)	.666 (16,92)	.139 (3,53)
17W09600	W 9600	.960 (24,38)	.692 (17,58)	.126 (3,20)
17W09806	W 9806	.980 (24,89)	.343 (8,71)	.065 (1,65)
17W09841	W 9841	.984 (24,99)	.406 (10,31)	.125 (3,18)
17W09843	W 9843	.984 (24,99)	.433 (11,00)	.088 (2,24)
17W09851	W 9851	.983 (24,97)	.360 (9,14)	.120 (3,05)
17W09852	W 9852	.995 (25,27)	.416 (10,57)	.060 (1,52)
17W09853	W 9853	1.000 (25,40)	.781 (19,84)	.075 (1,91)
17W09854	W 9854	1.000 (25,40)	.333 (8,46)	.385 (9,78)
17W09855	W 9855	.990 (25,15)	.337 (8,56)	.292 (7,42)
17W09856	W 9856	1.000 (25,40)	.339 (8,61)	.154 (3,91)
17W09900	W 9900	1.000 (25,40)	.375 (9,53)	.062 (1,57)
17W09901	W 9901	1 (25,40)	.76 (19,30)	.062 (1,57)
17W09902	W 9902	1.003 (25,48)	.485 (12,32)	.173 (4,39)
17W09903	W 9903	1.006 (25,55)	.189 (4,80)	.040 (1,02)
17W09904	W 9904	1.030 (26,16)	.550 (13,97)	.062 (1,57)
17W09905	W 9905	1.000 (25,40)	.760 (19,30)	.281 (7,14)
17W09906	W 9906	1.000 (25,40)	.515 (13,08)	.093 (2,38)
17W09907	W 9907	1.000 (25,40)	.750 (19,05)	.125 (3,17)
17W09930	W 9930	.993 (25,22)	.771 (19,58)	.124 (3,15)
17W09931	W 9931	1.000 (25,40)	.390 (9,91)	.250 (6,35)
17W09932	W 9932	1.000 (25,40)	.390 (9,91)	.175 (4,45)
17W09933	W 9933	1.000 (25,40)	.531 (13,49)	.062 (1,57)
17W09934	W 9934	1.000 (25,40)	.297 (7,54)	.063 (1,60)
17W09935	W 99345	1.000 (25,40)	.390 (9,91)	.094 (2,38)
17W10000	W 10000	1.000 (25,40)	.156 (3,96)	.062 (1,57)
17W10001	W 10001	1.000 (25,40)	.450 (11,43)	.125 (3,18)
17W10002	W 10002	1.000 (25,40)	.406 (10,31)	.062 (1,57)
17W10003	W 10003	1.00 (25,40)	.562 (14,27)	.125 (3,18)
17W10005	W 10005	1.000 (25,40)	.632 (16,05)	.185 (4,70)
17W10006	W 10006	1.000 (25,40)	.518 (13,16)	.080 (2,03)
17W10007	W 10007	1.000 (25,40)	.730 (18,54)	.062 (1,57)
17W10008	W 10008	1.000 (25,40)	.631 (16,03)	.128 (3,25)
17W10009	W 10009	1.000 (25,40)	.320 (8,13)	.375 (9,53)
17W10010	W 10010	1.000 (25,40)	.505 (12,83)	.125 (3,18)
17W10011	W 10011	1.004 (25,40)	.631 (16,03)	.065 (1,65)
17W10012	W 10012	1.000 (25,40)	.254 (6,45)	.325 (8,26)
17W10013	W 10013	1 (25,40)	.312 (7,92)	.032 (0,81)
17W10014	W 10014	1 (25,40)	5/16 (7,94)	3/16 (4,76)
17W10015	W 10015	1 (25,40)	17/64 (6,74)	5/16 (7,94)
17W10016	W 10016	1.000 (25,40)	.500 (12,70)	.100 (2,54)
17W10017	W 10017	1.000 (25,40)	.755 (19,18)	.175 (4,45)
17W10018	W 10018	1.500 (38,10)	1.015 (25,78)	.250 (6,35)
17W10019	W 10019	1" (25,40)	.665 (16,89)	.125 (3,18)
17W10020	W 10020	1.000 (25,40)	.326 (8,28)	.125 (3,18)

New
SIZES

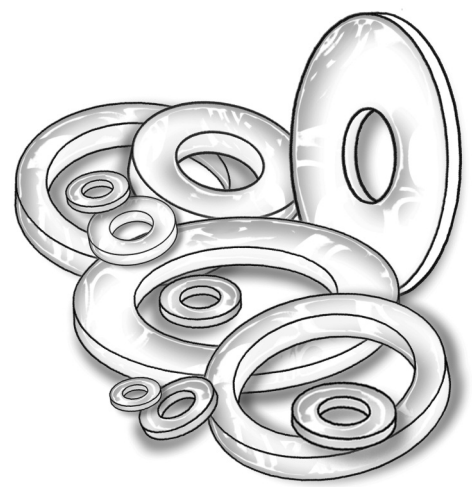
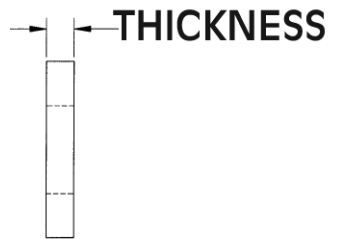
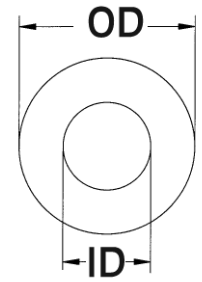

WASHERS, SHOULDER WASHERS & SCREW INSULATORS

SECTION IV

**New
SIZES**

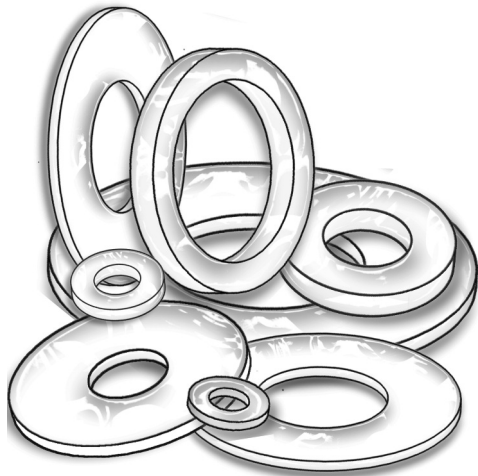
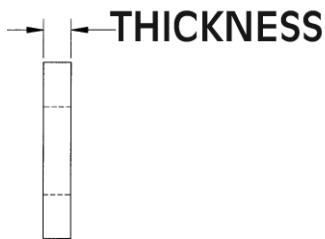
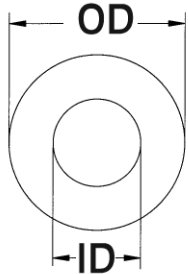

SPECIAL FLAT WASHERS

Molded in Natural Nylon 6/6

ITEM NUMBER	DESCRIPTION	OD	ID	THICKNESS
17W10021	W 10021	1.000 (25,40)	.194 (4,93)	.160 (4,06)
17W10022	W 10022	1.024 (26,01)	.563 (14,30)	.220 (5,59)
17W10023	W 10023	1" (25,40)	1/2" (12,70)	1/16" (1,59)
17W10024	W 10024	1.000 (25,40)	.093 (2,36)	.125 (3,18)
17W10025	W 10025	.995 (25,27)	.635 (16,13)	.250 (6,35)
17W10027	W 10027	1.000 (25,40)	.500 (12,70)	.187 (4,75)
17W10028	W 10028	1.000 (25,40)	.509 (12,93)	.125 (3,18)
17W10029	W 10029	1.000 (25,40)	.640 (16,26)	.128 (3,25)
17W10030	W 10030	1.000 (25,40)	.440 (11,18)	.060 (1,52)
17W10031	W 10031	1.024 (26,01)	.642 (16,31)	.060 (1,52)
17W10032	W 10032	1" (25,40)	.510 (12,95)	1/16 (1,57)
17W10033	W 10033	1.000 (25,40)	.625 (15,88)	.032 (0,81)
17W10034	W 10034	1.002 (25,45)	.503 (12,77)	.150 (3,81)
17W10041	W 10041	1.000 (25,40)	.264 (6,71)	.070 (1,78)
17W10042	W 10042	.750 (19,05)	.515 (13,08)	.250 (6,35)
17W10043	W 10043	1.000 (25,40)	.265 (6,73)	.262 (6,65)
17W10044	W 10044	1.000 (25,40)	.636 (16,15)	.094 (2,38)
17W10060	W 10060	1.006 (25,52)	.189 (4,80)	.064 (1,63)
17W10100	W 10100	1.010 (25,65)	.410 (10,41)	.100 (2,54)
17W10311	W 10311	1.031 (26,19)	.844 (21,44)	.040 (1,02)
17W10570	W 10570	1.057 (26,85)	.812 (20,62)	.125 (3,18)
17W10571	W 10571	1 (25,40)	.844 (21,44)	.125 (3,18)
17W10620	W 10620	1.060 (26,92)	.740 (18,80)	.10 (2,54)
17W10622	W 10622	1.062 (26,97)	.740 (18,80)	.225 (5,72)
17W10623	W 10623	1.107 (28,12)	.855 (21,72)	.058 (1,47)
17W10624	W 10624	1.062 (26,97)	.531 (13,49)	.062 (1,57)
17W10625	W 10625	1.055 (26,80)	.406 (10,31)	1/4 (6,35)
17W10626	W 10626	1.102 (28,00)	.728 (18,49)	.039 (0,99)
17W10627	W 10627	1.135 (28,83)	1.022 (25,96)	.500 (12,70)
17W10628	W 10628	1.102 (27,99)	.625 (15,83)	.118 (2,99)
17W11000	W 11000	1.128 (28,65)	.605 (15,37)	.239 (6,07)
17W11001	W 11001	1.181 (30,00)	.413 (10,49)	.098 (2,49)
17W11002	W 11002	1.117 (28,37)	.875 (22,23)	.195 (4,95)
17W11004	W 11004	1.125 (28,57)	.156 (3,96)	.250 (6,35)
17W11005	W 11005	1.181 (30,00)	.827 (21,01)	.157 (3,99)
17W11140	W 11140	1.114 (28,30)	.840 (21,34)	.127 (3,23)
17W11202	W 11202	1.120 (28,45)	.390 (9,91)	.125 (3,18)
17W11203	W 11203	1.120 (28,45)	.503 (12,78)	.033 (0,84)
17W11204	W 11204	1.120 (28,45)	.635 (16,13)	.140 (3,56)
17W11210	W 11210	1-1/8 (28,58)	.320 (8,13)	.062 (1,57)
17W11211	W 11211	1.121 (28,47)	.316 (8,03)	.034 (0,86)
17W11212	W 11212	1.13 (28,70)	.63 (16,00)	1/16 (1,59)
17W11251	W 11251	1.120 (28,45)	.540 (13,72)	.125 (3,18)
17W11252	W 11252	1.102 (27,99)	.592 (15,04)	.098 (2,50)
17W11256	W 11256	1.125 (28,58)	.889 (22,58)	.060 (1,52)
17W11257	W 11257	1.125 (28,58)	.500 (12,70)	.062 (1,57)
17W11258	W 11258	1.125 (28,58)	.763 (19,38)	.125 (3,18)
17W11259	W 11259	1.125 (28,58)	.920 (23,37)	.126 (3,20)
17W11320	W 11320	1.132 (28,75)	.942 (23,93)	.130 (3,30)
17W11720	W 11720	1.17 (29,72)	.377 (9,58)	.125 (3,18)
17W11750	W 11750	1.175 (29,85)	.310 (7,87)	.125 (3,18)
17W11800	W 11800	1.184 (30,07)	.477 (12,12)	.079 (2,01)
17W12030	W 12030	1.220 (30,99)	.502 (12,75)	.150 (3,81)



WASHERS, SHOULDER WASHERS & SCREW INSULATORS

SECTION
IV

SPECIAL FLAT WASHERS

Molded in Natural Nylon 6/6

ITEM NUMBER	DESCRIPTION	OD	ID	THICKNESS
17W12031	W 12031	1.203 (30,56)	.984 (24,99)	.050 (1,27)
17W12032	W 12032	1.28 (32,57)	.88 (22,35)	.062 (1,57)
17W12181	W 12181	1.218 (30,94)	1.031 (26,19)	.040 (1,02)
17W12250	W 12250	1.225 (31,12)	.643 (16,33)	.100 (2,54)
17W12251	W 12251	1.245 (31,62)	1.001 (25,43)	.031 (0,79)
17W12501	W 12501	1.235 (31,37)	.365 (9,27)	.110 (2,79)
17W12502	W 12502	1.250 (31,75)	.875 (22,23)	.125 (3,18)
17W12503	W 12503	1.250 (31,75)	.765 (19,43)	.080 (2,03)
17W12504	W 12504	1.250 (31,75)	.516 (13,11)	.062 (1,57)
17W12505	W 12505	1.267 (32,18)	.390 (9,91)	.045 (1,14)
17W12506	W 12506	1.250 (31,75)	.250 (6,35)	.255 (6,48)
17W12507	W 12507	1.250 (31,75)	.805 (20,45)	.060 (1,52)
17W12508	W 12508	1.250 (31,75)	.281 (7,14)	.063 (1,60)
17W12509	W 12509	1 1/4 (31,75)	9/16 (14,29)	1/32 (0,79)
17W12510	W 12510	1.250 (31,75)	.812 (20,62)	.080 (2,03)
17W12511	W 12511	1 17/64 (32,13)	.390 (9,90)	.156 (3,96)
17W12512	W 12512	1.250 (31,75)	.380 (9,66)	.125 (3,18)
17W12513	W 12513	1.250 (31,75)	.310 (7,87)	.120 (3,05)
17W12515	W 12515	1.250 (31,75)	.226 (5,74)	.125 (3,18)
17W12516	W 12516	1 1/4" (31,75)	.260 (6,60)	.060 (1,52)
17W12517	W 12517	1.250 (31,75)	.839 (21,31)	.040 (1,02)
17W12518	W 12518	1.250 (31,75)	.437 (11,10)	.125 (3,18)
17W12519	W 12519	1.250 (31,75)	.886 (22,50)	.105 (2,59)
17W12524	W 12524	1.240 (31,50)	.670 (17,02)	.060 (1,52)
17W12525	W 12525	1.260 (32,00)	.340 (8,64)	.250 (6,35)
17W12526	W 12526	1.250 (31,75)	.370 (9,40)	.250 (6,35)
17W12527	W 12527	1.250 (31,75)	.257 (6,53)	.255 (6,48)
17W12528	W 12528	1.250 (31,75)	.270 (6,86)	.080 (2,03)
17W12562	W 12562	1 1/4 (31,75)	.250 (6,35)	.062 (1,57)
17W12580	W 12580	1.258 (31,95)	.226 (5,74)	.065 (1,65)
17W12593	W 12593	1.250 (31,75)	.100 (2,54)	.060 (1,52)
17W12604	W 12604	1.27 (32,36)	.400 (10,16)	.062 (1,57)
17W12606	W 12606	1.270 (32,26)	.548 (13,92)	.166 (4,22)
17W13101	W 13101	1.310 (33,27)	.645 (16,38)	.120 (3,05)
17W13119	W 13119	1.312 (33,32)	.510 (12,95)	.400 (10,16)
17W13120	W 13120	1.312 (33,32)	1.000 (25,40)	.191 (4,85)
17W13121	W 13121	1.312 (33,32)	1.088 (27,36)	.062 (1,57)
17W13122	W 13122	1.312 (33,32)	1.000 (25,40)	.125 (3,18)
17W13123	W 13123	1.375 (34,93)	.640 (16,26)	.090 (2,29)
17W13124	W 13124	1.312 (33,32)	.656 (16,66)	.095 (2,41)
17W13125	W 13125	1.312 (33,32)	1.026 (26,06)	.191 (4,85)
17W13126	W 13126	1.312 (33,32)	.625 (15,88)	.050 (1,27)
17W13127	W 13127	1.312 (33,32)	.656 (16,66)	.189 (4,80)
17W13747	W 13747	1.375 (34,93)	.781 (19,84)	.063 (1,60)
17W13748	W 13748	1.375 (34,93)	.250 (6,35)	.750 (19,05)
17W13749	W 13749	1.370 (24,80)	.380 (7,65)	.125 (3,18)
17W13750	W 13750	1.375 (34,93)	.250 (6,35)	.064 (7,63)
17W13751	W 13751	1.375 (34,93)	.525 (13,34)	.125 (3,18)
17W13752	W 13752	1.375 (34,93)	.510 (12,95)	.062 (1,57)
17W13753	W 13753	1.375 (34,93)	.656 (16,66)	.125 (3,18)
17W13754	W 13754	1.375 (34,93)	.330 (8,32)	.125 (3,18)
17W13755	W 13755	1.31 (33,27)	.938 (23,82)	.040 (1,02)
17W13756	W 13756	1.363 (34,62)	.523 (13,28)	.051 (1,30)

New
SIZES

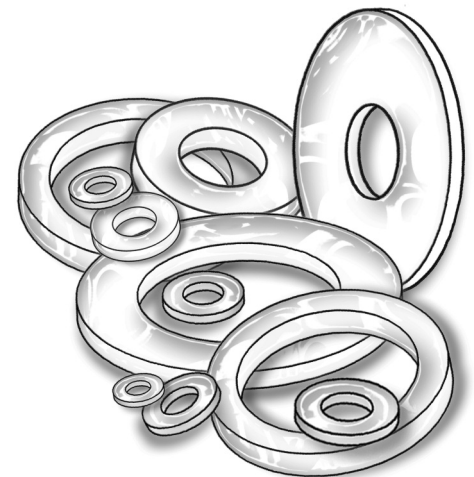
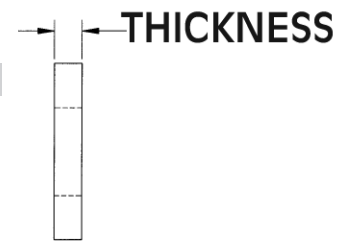
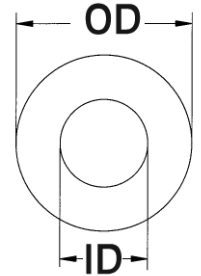

WASHERS, SHOULDER WASHERS & SCREW INSULATORS

SECTION
IV

**New
SIZES**

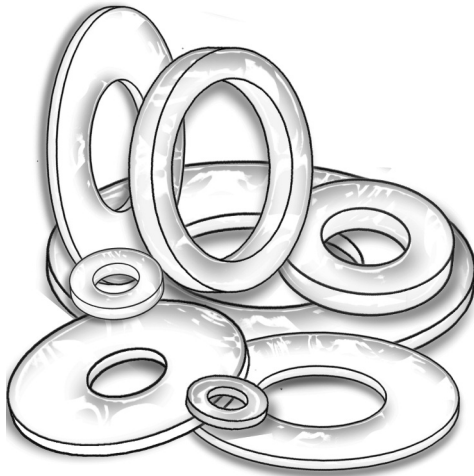
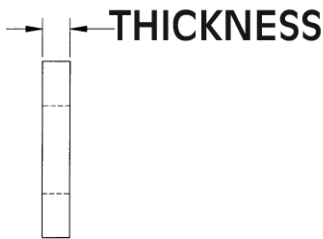
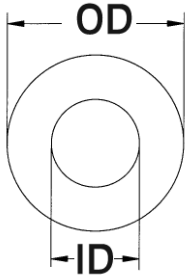

SPECIAL FLAT WASHERS

Molded in **Natural Nylon 6/6**

ITEM NUMBER	DESCRIPTION	OD	ID	THICKNESS
17W13757	W 13757	1.375 (34,93)	.450 (11,43)	.090 (2,29)
17W13758	W 13758	1.375 (34,93)	.530 (13,46)	.173 (4,39)
17W13759	W 13759	1.375 (34,93)	1.015 (25,78)	.125 (3,18)
17W13760	W 13760	1 3/8 (34,93)	.470 (11,94)	.093 (2,36)
17W13761	W 13761	1.378 (35,00)	.433 (11,00)	.157 (4,00)
17W13762	W 13762	1.375 (34,92)	1.031 (26,18)	.500 (12,70)
17W13763	W 13763	1.361 (34,56)	.405 (10,28)	.082 (2,08)
17W14250	W 14250	1.420 (36,07)	.760 (19,30)	.100 (2,54)
17W14251	W 14251	1.395 (35,43)	.250 (6,35)	.118 (3,00)
17W14252	W 14252	1.485 (37,72)	.755 (19,18)	.197 (5,00)
17W14371	W 14371	1.437 (36,50)	1.000 (25,40)	.069 (1,75)
17W14501	W 14501	1.450 (36,83)	1.000 (25,40)	.063 (1,65)
17W14502	W 14502	1.450 (36,83)	.990 (25,15)	.120 (3,05)
17W14610	W 14610	1.460 (37,08)	1.180 (29,97)	.100 (2,54)
17W14681	W 14681	1.468 (37,29)	.515 (13,08)	.050 (1,27)
17W14930	W 14930	1.500 (38,10)	.437 (11,10)	.130 (3,30)
17W14931	W 14931	1 1/2 (38,10)	.505 (12,83)	.125 (3,18)
17W14932	W 14932	1.500 (38,10)	.265 (6,73)	.375 (9,53)
17W14933	W 14933	1 1/2 (38,10)	5/16 (7,94)	1/16 (1,59)
17W14934	W 14934	1.500 (38,10)	.390 (9,91)	.060 (1,52)
17W15000	W 15000	1.500 (38,10)	.188 (4,75)	.068 (1,72)
17W15001	W 15001	1.500 (38,10)	.665 (16,89)	.094 (2,39)
17W15002	W 15002	1.500 (38,10)	.500 (12,70)	.125 (3,18)
17W15003	W 15003	1.500 (38,10)	.375 (9,53)	.375 (9,53)
17W15004	W 15004	1.500 (38,10)	.755 (19,18)	.130 (3,30)
17W15005	W 15005	1.500 (38,10)	.696 (17,68)	.120 (3,05)
17W15006	W 15006	1.490 (37,85)	.521 (13,23)	.120 (3,05)
17W15007	W 15007	1.575 (40,01)	.659 (16,74)	.118 (3,00)
17W15008	W 15008	1.500 (38,10)	1.015 (25,78)	.080 (2,03)
17W15009	W 15009	1 1/2 (38,10)	1 1/4 (31,75)	1/8 (3,18)
17W15010	W 15010	1.493 (37,92)	.604 (15,34)	.220 (5,59)
17W15011	W 15011	1 1/2 (38,10)	.335 (8,51)	.125 (3,18)
17W15012	W 15012	1.500 (38,10)	.505 (12,83)	.130 (3,30)
17W15013	W 15013	1.500 (38,10)	.507 (12,88)	.250 (6,35)
17W15014	W 15014	1.468 (37,29)	1.010 (25,65)	.112 (2,84)
17W15016	W 15016	1 1/2 (38,10)	.505 (12,83)	.210 (5,33)
17W15017	W 15017	1 1/2 (38,10)	.203 (5,16)	.068 (1,73)
17W15018	W 15018	1.575 (40,01)	.236 (5,99)	.119 (3,02)
17W15019	W 15019	1.500 (38,10)	.449 (11,40)	.075 (1,90)
17W15020	W 15020	1.500 (38,10)	.750 (19,05)	.250 (6,35)
17W15031	W 15031	1.500 (38,10)	.515 (13,08)	.7/16 (11,11)
17W15050	W 15050	1.505 (38,23)	.750 (19,05)	.053 (1,35)
17W15051	W 15051	1.49 (37,85)	.81 (20,57)	.062 (1,57)
17W15052	W 15052	1.57 (39,87)	.512 (13,00)	.118 (3,00)
17W15053	W 15053	1.575 (40,01)	.795 (20,19)	.039 (0,99)
17W15054	W 15054	1.500 (38,10)	.790 (20,06)	.120 (3,04)
17W15400	W 15400	1.540 (39,12)	1.164 (29,57)	.192 (4,88)
17W15620	W 15620	1.563 (39,70)	1" (25,40)	.062 (1,57)
17W15625	W 15625	1-9/16 (39,70)	.630 (16,00)	.062 (1,57)
17W16240	W 16240	1.619 (41,12)	1.495 (37,97)	.245 (6,22)
17W16250	W 16250	1.625 (41,28)	.531 (13,49)	.312 (7,92)
17W16251	W 16251	1.625 (41,28)	1.375 (34,93)	.110 (2,79)
17W16252	W 16252	1.625 (41,28)	1.0 (25,40)	.187 (4,75)



WASHERS, SHOULDER WASHERS & SCREW INSULATORS

SECTION
IV

SPECIAL FLAT WASHERS

Molded in **Natural Nylon 6/6**

ITEM NUMBER	DESCRIPTION	OD	ID	THICKNESS
17W16253	W 16253	1.625 (41,28)	.940 (23,88)	.060 (1,52)
17W16300	W 16300	1.635 (41,53)	1.405 (35,69)	.093 (2,36)
17W16301	W 16301	1.628 (41,35)	1.508 (38,30)	.072 (1,83)
17W16514	W 16514	1.650 (41,91)	1.395 (35,43)	.140 (3,56)
17W16900	W 16900	1.695 (43,05)	1.255 (31,88)	.065 (1,65)
17W16901	W 16901	1.693 (43,00)	.669 (16,99)	.236 (5,99)
17W17181	W 17181	1.718 (43,64)	.625 (15,88)	.050 (1,27)
17W17241	W 17241	1.724 (43,79)	1.500 (38,10)	.032 (0,81)
17W17242	W 17242	1.750 (44,45)	.812 (20,62)	.125 (3,18)
17W17251	W 17251	1.425 (36,90)	.697 (17,70)	.100 (2,54)
17W17252	W 17252	1.490 (37,85)	.765 (19,43)	.100 (2,54)
17W17500	W 17500	1.750 (44,45)	.928 (23,57)	.275 (6,99)
17W17501	W 17501	1.765 (44,83)	.656 (16,66)	.100 (2,54)
17W18001	W 18001	1.800 (45,72)	.948 (24,08)	.057 (1,45)
17W18500	W 18500	1.850 (46,99)	1.028 (26,11)	.120 (3,05)
17W19060	W 19060	1.906 (48,41)	1.500 (38,10)	.093 (2,36)
17W19061	W 19061	1.969 (50,01)	.504 (12,80)	.125 (3,17)
17W20001	W 20001	2.01 (51,05)	1.28 (32,51)	.135 (3,43)
17W20002	W 20002	2.000 (50,80)	.510 (12,95)	.060 (1,52)
17W20003	W 20003	2.000 (50,80)	1.525 (38,75)	.060 (1,52)
17W20004	W 20004	2.000 (50,80)	1.080 (27,43)	.160 (4,06)
17W20006	W 20006	2.000 (50,80)	.630 (16,00)	.125 (3,18)
17W20007	W 20007	2.000 (50,80)	.390 (9,91)	.062 (1,57)
17W20008	W 20008	2 (50,80)	.635 (16,13)	.060 (1,52)
17W20009	W 20009	2.007 (50,98)	.315 (8,00)	.197 (5,00)
17W20012	W 20012	1.985 (50,42)	1.525 (38,75)	.125 (3,18)
17W20013	W 20013	2.000 (50,80)	1.325 (33,66)	.310 (7,87)
17W20014	W 20014	2.250 (57,15)	1.410 (35,81)	.130 (3,30)
17W20015	W 20015	2.150 (54,61)	.275 (6,99)	.125 (3,18)
17W20062	W 20062	2 (50,80)	.805 (20,45)	.062 (1,57)
17W20600	W 20600	2.060 (52,32)	1.800 (45,72)	.055 (1,40)
17W21350	W 21350	2 9/64 (54,38)	1.760 (44,70)	.130 (3,30)
17W21850	W 21850	2.180 (55,37)	1.420 (36,07)	.050 (1,27)
17W22005	W 22005	2.205 (56,01)	1.720 (43,69)	.050 (1,27)
17W22500	W 22500	2 1/4 (57,15)	1 (25,40)	.075 (1,91)
17W22800	W 22800	2.275 (57,79)	1.275 (32,39)	.120 (3,05)
17W25001	W 25001	2.500 (63,50)	1.075 (27,31)	.125 (3,18)
17W25002	W 25002	2.500 (63,50)	.800 (20,32)	.063 (1,60)
17W25003	W 25003	2.500 (63,50)	1.750 (44,45)	.125 (3,18)
17W26802	W 26802	2.69 (68,33)	1.93 (49,02)	.125 (3,18)
17W29300	W 29300	2.930 (74,42)	.632 (16,05)	.150 (3,81)
17W29503	W 29503	2.935 (74,93)	1.125 (28,60)	.093 (2,54)
17W30000	W 30000	3.005 (76,32)	1.270 (32,26)	.093 (2,36)
17W30002	W 30002	2.970 (75,44)	1.490 (37,85)	.125 (3,18)
17W30003	W 30003	3.016 (76,61)	2.800 (71,12)	.122 (3,10)
17W30300	W 30300	3.600 (91,44)	3.030 (76,96)	.075 (1,91)
17W30062	W 30062	2-31/32 (75,41)	.805 (20,45)	1/16 (1,59)
17W30073	W 30073	3.016 (76,61)	2.80 (71,12)	.072 (1,83)
17W30093	W 30093	3.005 (76,33)	1.625 (41,28)	.093 (2,36)
17W31250	W 31250	3.132 (79,55)	.812 (20,62)	.125 (3,18)
17W32600	W 32600	3.260 (82,80)	2.620 (66,55)	.062 (1,57)
17W37500	W 37500	3.750 (95,25)	.375 (9,53)	.062 (1,57)

New
SIZES

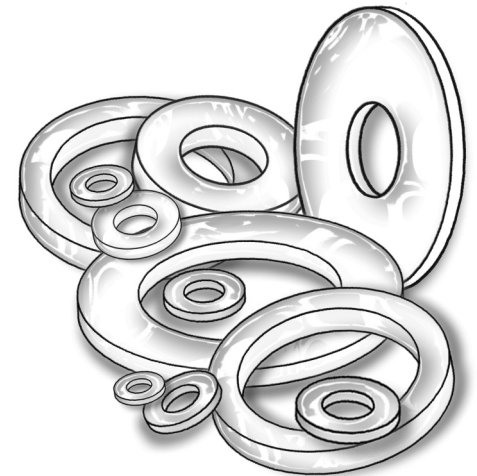
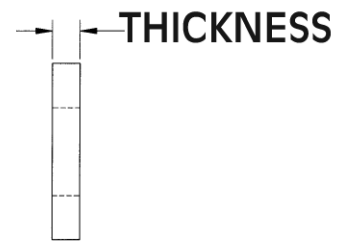
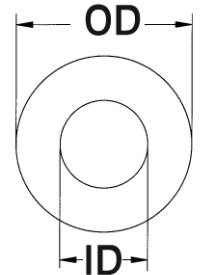

WASHERS, SHOULDER WASHERS & SCREW INSULATORS

SECTION IV

SHOULDER WASHERS

Molded in **Natural Nylon 6/6**

Nylon Shoulder Washers are suitable for a large variety of insulation and mechanical applications.

- ▶ THEY INSULATE
- ▶ REDUCE VIBRATION
- ▶ ACT AS SPACERS AND GUIDES
- ▶ STRONG AND CORROSION RESISTANT
- ▶ CAN BE USED AS SEAL IN SOME APPLICATIONS

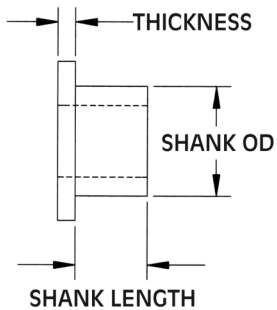
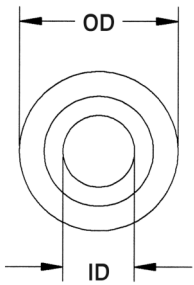

ITEM NUMBER	DESCRIPTION	SHANK LENGTH	OD	THICKNESS	SHANK OD	ID
12SWS0151	SWS 151	.125 (3,18)	.197 (5,00)	.031 (0,79)	.114 (2,90)	.075 (1,95)
12SWS0152	SWS 152	3/64 (1,19)	.105 (2,67)	3/64 (1,19)	.084 (2,13)	.061 (1,55)
12SWS0155	SWS 155	.060 (1,52)	.125 (3,18)	.030 (0,76)	.080 (2,03)	.055 (1,40)
12SWS0156	SWS 156	1/32 (0,79)	.228 (5,79)	1/32 (0,79)	.122 (3,10)	.093 (2,36)
12SWS0157	SWS 157	.035 (0,89)	.235 (5,97)	.095 (2,41)	.147 (3,73)	.115 (2,92)
12SWS0158	SWS 158	.250 (6,35)	.187 (4,75)	.047 (1,19)	.120 (3,05)	.090 (2,29)
12SWS0159	SWS 159	.206 (5,28)	.187 (4,75)	.156 (3,96)	.156 (3,96)	.096 (2,44)
12SWS0179	SWS 179	.075 (1,91)	.181 (4,60)	.046 (1,17)	.120 (3,05)	.024 (0,61)
12SWS0180	SWS 180	.075 (1,91)	.181 (4,60)	3/64 (1,19)	.120 (3,05)	.045 (1,14)
12SWS0181	SWS 181	.125 (3,18)	.197 (5,00)	.031 (0,79)	.118 (3,00)	.075 (1,91)
12SWS0183	SWS 183	1/32 (0,79)	.182 (4,62)	5/64 (1,98)	.125 (3,18)	.085 (2,16)
12SWS0184	SWS 184	1/32 (0,79)	.189 (4,80)	1/16 (1,59)	.119 (3,02)	.095 (2,41)
12SWS0185	SWS 185	.106 (2,69)	.433 (10,10)	.161 (4,09)	.259 (6,58)	.197 (5,00)
12SWS0186	SWS 186	.088 (2,24)	.228 (5,79)	.039 (0,99)	.140 (3,56)	.098 (2,49)
12SWS0187	SWS 187	1/64 (0,41)	.187 (4,75)	1/32 (0,79)	.119 (3,02)	.089 (2,26)
12SWS0188	SWS 188	.030 (0,76)	.187 (4,75)	.030 (0,76)	.131 (3,33)	.090 (2,29)
12SWS0189	SWS 189	.020 (0,51)	.187 (4,75)	.030 (0,76)	.119 (3,02)	.090 (2,29)
12SWS0190	SWS 190	9/32 (7,14)	.197 (5,00)	1/32 (0,79)	.118 (3,00)	.075 (1,91)
12SWS0191	SWS 191	.100 (2,54)	.350 (8,89)	.090 (2,29)	.200 (5,08)	.140 (3,56)
12SWS0192	SWS 192	.052 (1,32)	.253 (6,43)	.047 (1,19)	.136 (3,45)	.120 (3,05)
12SWS0193	SWS 193	.040 (1,02)	.250 (6,35)	.031 (0,79)	.140 (3,56)	.093 (2,36)
12SWS0194	SWS 194	.046 (1,17)	.197 (5,00)	.027 (0,69)	.144 (3,66)	.118 (3,00)
12SWS0195	SWS 195	1/16 (1,59)	.195 (4,95)	1/32 (0,79)	.120 (3,05)	.093 (2,36)
12SWS0196	SWS 196	3/64 (1,19)	.240 (6,09)	1/16 (1,59)	.135 (3,42)	.114 (2,89)
12SWS0197	SWS 197	1/32 (0,79)	.216 (5,48)	3/64 (1,19)	.135 (3,42)	.115 (2,92)
12SWS0198	SWS 198	1/32 (0,79)	.200 (5,08)	1/32 (0,79)	.140 (3,56)	.115 (2,92)
12SWS0199	SWS 199	5/64 (1,98)	.187 (4,75)	1/32 (0,79)	.119 (3,02)	.063 (1,60)
12SWS0200	SWS 200	1/32 (0,79)	.200 (5,08)	5/64 (1,98)	.135 (3,43)	.116 (2,95)
12SWS0201	SWS 201	3/16 (4,76)	.187 (4,75)	1/32 (0,79)	.119 (3,02)	.063 (1,60)
12SWS0202	SWS 202	5/64 (1,98)	.205 (5,21)	1/32 (0,79)	.125 (3,18)	.093 (2,36)
12SWS0203	SWS 203	7/64 (2,77)	.208 (5,28)	1/32 (0,79)	.125 (3,18)	.093 (2,36)
12SWS0204	SWS 204	3/16 (4,76)	.205 (5,21)	1/32 (0,79)	.125 (3,18)	.093 (2,36)
12SWS0205	SWS 205	3/64 (1,19)	.202 (5,13)	1/64 (0,41)	.145 (3,68)	.120 (3,05)
12SWS0206	SWS 206	1/16 (1,59)	.224 (5,69)	1/32 (0,79)	.154 (3,91)	.120 (3,05)
12SWS0207	SWS 207	5/32 (3,97)	.242 (6,15)	3/64 (1,19)	.135 (3,43)	.110 (2,79)
12SWS0208	SWS 208	1/16 (1,59)	.200 (5,08)	1/32 (0,79)	.120 (3,05)	.093 (2,36)
12SWS0209	SWS 209	3/64 (1,19)	.210 (5,33)	1/64 (0,41)	.145 (3,68)	.120 (3,05)
12SWS0210	SWS 210	3/64 (1,19)	.230 (5,84)	1/64 (0,41)	.142 (3,61)	.122 (3,10)
12SWS0211	SWS 211	1/32 (0,79)	.218 (5,54)	3/64 (1,19)	.135 (3,43)	.115 (2,92)
12SWS0212	SWS 212	7/16 (11,11)	.224 (5,69)	1/32 (0,79)	.154 (3,91)	.120 (3,05)
12SWS0213	SWS 213	3/64 (1,19)	.200 (5,08)	1/32 (0,79)	.138 (3,51)	.109 (2,77)
12SWS0214	SWS 214	1/32 (0,79)	.240 (6,09)	3/64 (1,19)	.137 (3,48)	.115 (2,77)
12SWS0215	SWS 215	7/32 (5,55)	.250 (6,35)	11/64 (4,37)	.150 (3,81)	.115 (2,92)
12SWS0216	SWS 216	1/32 (0,79)	.240 (6,10)	1/32 (0,79)	.150 (3,81)	.098 (2,49)
12SWS0217	SWS 217	1/32 (0,79)	.228 (5,79)	3/64 (1,19)	.138 (3,51)	.100 (2,54)
12SWS0218	SWS 218	1/8 (3,18)	.242 (6,15)	3/64 (1,19)	.140 (3,56)	.115 (2,92)



WASHERS, SHOULDER WASHERS & SCREW INSULATORS

SHOULDER WASHERS

Molded in **Natural Nylon 6/6**

SECTION
IV

Nylon Shoulder Washers are suitable for a large variety of insulation and mechanical applications.

- ▶ THEY INSULATE ▶ REDUCE VIBRATION ▶ ACT AS SPACERS AND GUIDES ▶ STRONG AND CORROSION RESISTANT ▶ CAN BE USED AS SEAL IN SOME APPLICATIONS

ITEM NUMBER	DESCRIPTION	SHANK LENGTH	OD	THICKNESS	SHANK OD	ID
12SWS0219	SWS 219	1/8 (3,18)	.290 (7,37)	1/64 (0,41)	.250 (6,35)	.193 (4,90)
12SWS0220	SWS 220	3/64 (1,19)	.234 (5,94)	3/64 (1,19)	.147 (3,73)	.115 (2,92)
12SWS0221	SWS 221	3/32 (2,38)	.235 (5,97)	3/64 (1,19)	.145 (3,68)	.115 (2,92)
12SWS0222	SWS 222	1/8 (3,18)	.235 (5,97)	3/64 (1,19)	.145 (3,68)	.115 (2,92)
12SWS0223	SWS 223	1/32 (0,79)	.250 (6,35)	1/16 (1,59)	.187 (4,75)	.140 (3,56)
12SWS0224	SWS 224	3/64 (1,19)	.260 (6,60)	1/16 (1,59)	.190 (4,83)	.140 (3,56)
12SWS0225	SWS 225	43/64 (17,02)	.250 (6,35)	3/64 (1,19)	.187 (4,75)	.095 (2,41)
12SWS0226	SWS 226	1/16 (1,59)	.250 (6,35)	1/32 (0,79)	.143 (3,63)	.118 (3,00)
12SWS0227	SWS 227	1/32 (0,79)	.257 (6,53)	1/16 (1,59)	.187 (4,75)	.141 (3,58)
12SWS0228	SWS 228	1/64 (0,41)	.260 (6,60)	1/64 (0,41)	.154 (3,91)	.095 (2,41)
12SWS0229	SWS 229	1/8 (3,18)	.250 (6,35)	3/64 (1,19)	.139 (3,53)	.118 (3,00)
12SWS0230	SWS 230	5/32 (3,97)	.265 (6,73)	1/32 (0,79)	.205 (5,21)	.142 (3,61)
12SWS0232	SWS 232	5/64 (1,98)	.253 (6,42)	3/64 (1,19)	.136 (3,45)	.120 (3,05)
12SWS0233	SWS 233	1/32 (0,79)	.203 (5,16)	3/64 (1,19)	.140 (3,56)	.115 (2,92)
12SWS0234	SWS 234	.050 (1,40)	.239 (6,07)	.020 (0,51)	.139 (3,53)	.116 (2,95)
12SWS0235	SWS 235	.033 (0,84)	.210 (5,33)	.042 (1,07)	.143 (3,63)	.116 (2,95)
12SWS0236	SWS 236	.020 (0,51)	.250 (6,35)	.030 (0,76)	.150 (3,81)	.116 (2,96)
12SWS0237	SWS 237	.040 (1,02)	.235 (5,97)	.047 (1,19)	.147 (3,73)	.115 (2,92)
12SWS0238	SWS 238	.030 (0,76)	.230 (5,84)	.040 (1,02)	.150 (3,81)	.125 (3,18)
12SWS0239	SWS 239	.090 (2,29)	.224 (5,69)	.028 (0,71)	.154 (3,91)	.120 (3,05)
12SWS0240	SWS 240	.100 (2,54)	.230 (5,84)	.025 (0,64)	.190 (4,83)	.150 (3,81)
12SWS0241	SWS 241	.155 (3,94)	.224 (5,69)	.028 (0,71)	.154 (3,91)	.120 (3,05)
12SWS0242	SWS 242	3/32 (2,38)	.635 (16,13)	9/64 (3,57)	.425 (10,80)	.201 (5,11)
12SWS0243	SWS 243	.063 (1,60)	15/64 (5,94)	.025 (0,64)	.164 (4,17)	.130 (3,30)
12SWS0244	SWS 244	.031 (0,79)	.234 (5,94)	.025 (0,64)	.145 (3,68)	.115 (2,92)
12SWS0245	SWS 245	.093 (2,36)	.235 (5,97)	.250 (6,35)	.145 (3,68)	.115 (2,92)
12SWS0246	SWS 246	.027 (0,69)	.240 (6,10)	.047 (1,19)	.134 (3,40)	.115 (2,92)
12SWS0247	SWS 247	3/64 (1,19)	.252 (6,40)	3/64 (1,19)	.140 (3,56)	.115 (2,92)
12SWS0248	SWS 248	.090 (2,29)	.290 (7,37)	.060 (1,52)	.205 (5,21)	.125 (3,18)
12SWS0249	SWS 249	.177 (4,50)	.244 (6,20)	.040 (1,02)	.157 (3,99)	.118 (3,00)
12SWS0250	SWS 250	.156 (3,96)	.265 (6,73)	.118 (3,00)	.205 (5,21)	.142 (3,61)
12SWS0251	SWS 251	.031 (0,79)	.250 (6,35)	.031 (0,79)	.154 (3,91)	.093 (2,36)
12SWS0252	SWS 252	3/64 (1,19)	.240 (6,10)	.130 (3,30)	.138 (3,51)	.114 (2,90)
12SWS0253	SWS 253	.052 (1,32)	.200 (5,08)	.078 (1,98)	.135 (3,43)	.120 (3,05)
12SWS0254	SWS 254	.281 (7,13)	.203 (5,16)	.040 (1,02)	.156 (3,96)	.100 (2,54)
12SWS0255	SWS 255	1/8 (2,94)	.500 (12,70)	1/8 (2,94)	.375 (9,53)	.285 (7,14)
12SWS0256	SWS 256	.100 (2,54)	.243 (6,17)	.060 (1,52)	.199 (5,05)	.125 (3,18)
12SWS0257	SWS 257	.280 (7,11)	.250 (6,35)	.046 (1,17)	.150 (3,81)	.118 (3,00)
12SWS0258	SWS 258	.250 (6,35)	.283 (7,19)	.045 (1,14)	.199 (5,05)	.123 (3,12)
12SWS0259	SWS 259	.250 (6,35)	.320 (8,12)	.050 (1,27)	.198 (5,02)	.168 (4,26)
12SWS0280	SWS 280	.185 (4,70)	.280 (7,11)	.042 (1,07)	.150 (3,81)	.112 (2,84)
12SWS0290	SWS 290	1/32 (0,79)	.290 (7,37)	3/64 (1,19)	.170 (4,32)	.140 (3,56)
12SWS0291	SWS 291	.375 (9,53)	.290 (7,37)	.234 (5,94)	.170 (4,32)	.140 (3,56)
12SWS0296	SWS 296	.375 (9,53)	.499 (12,67)	.125 (3,18)	.295 (7,49)	.187 (4,75)
12SWS0300	SWS 300	.090 (2,29)	.250 (6,35)	.050 (1,27)	.150 (3,81)	.120 (3,05)
12SWS0301	SWS 301	.065 (1,65)	.250 (6,35)	.030 (0,76)	.140 (3,56)	.098 (2,49)

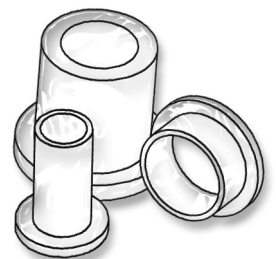
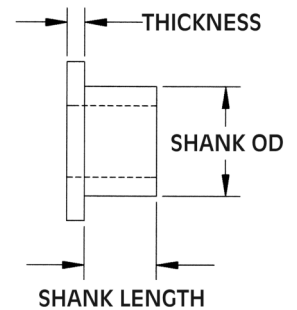
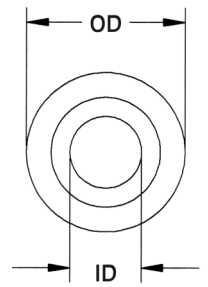

WASHERS, SHOULDER WASHERS & SCREW INSULATORS

SECTION IV

SHOULDER WASHERS

Molded in **Natural Nylon 6/6**

Nylon Shoulder Washers are suitable for a large variety of insulation and mechanical applications.

- ▶ THEY INSULATE
- ▶ REDUCE VIBRATION
- ▶ ACT AS SPACERS AND GUIDES
- ▶ STRONG AND CORROSION RESISTANT
- ▶ CAN BE USED AS SEAL IN SOME APPLICATIONS

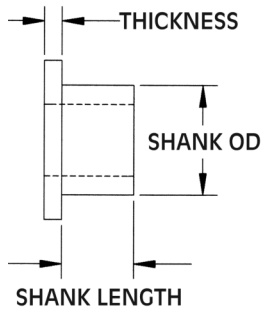
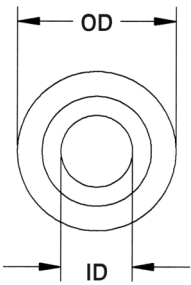

ITEM NUMBER	DESCRIPTION	SHANK LENGTH	OD	THICKNESS	SHANK OD	ID
12SWS0302	SWS 302	.039 (0,99)	.210 (5,33)	.032 (0,81)	.141 (3,58)	.118 (3,00)
12SWS0303	SWS 303	.180 (4,57)	.250 (6,35)	.050 (1,27)	.150 (3,18)	.120 (3,05)
12SWS0304	SWS 304	.453 (11,51)	.256 (6,50)	.055 (1,40)	.173 (4,39)	.118 (3,00)
12SWS0305	SWS 305	.120 (3,05)	.250 (6,35)	.050 (1,27)	.135 (3,43)	.118 (3,00)
12SWS0306	SWS 306	.062 (1,57)	.250 (6,35)	.031 (0,79)	.150 (3,81)	.116 (2,95)
12SWS0307	SWS 307	.029 (0,74)	.281 (7,14)	.059 (1,50)	.178 (4,52)	.110 (2,79)
12SWS0308	SWS 308	.018 (0,46)	.245 (6,22)	.062 (1,57)	.150 (3,81)	.113 (2,87)
12SWS0309	SWS 309	.040 (1,02)	.234 (5,94)	.046 (1,17)	.132 (3,35)	.105 (2,67)
12SWS0310	SWS 310	.250 (6,35)	.250 (6,35)	.047 (1,19)	.156 (3,96)	.125 (3,18)
12SWS0311	SWS 311	.437 (11,10)	.260 (6,60)	.032 (0,81)	.158 (4,01)	.125 (3,18)
12SWS0312	SWS 312	.190 (4,83)	.575 (14,61)	.030 (0,76)	.365 (9,27)	.312 (7,92)
12SWS0361	SWS 361	.018 (0,45)	.500 (12,70)	.075 (1,90)	.240 (6,09)	.140 (3,55)
12SWS0363	SWS 363	.031 (0,79)	.437 (11,10)	.062 (1,57)	.240 (6,10)	.194 (4,93)
12SWS0364	SWS 364	.453 (11,51)	.364 (9,24)	.055 (1,40)	.244 (6,20)	.197 (5,00)
12SWS0380	SWS 380	.070 (1,78)	.255 (6,48)	.040 (1,02)	.145 (3,68)	.120 (3,05)
12SWS0390	SWS 390	.023 (0,58)	.312 (7,92)	.030 (0,76)	.197 (5,00)	.126 (3,20)
12SWS0391	SWS 391	.072 (1,82)	.279 (7,08)	.042 (1,06)	.140 (3,55)	.110 (2,79)
12SWS0392	SWS 392	.050 (1,27)	.312 (7,92)	.062 (1,57)	.185 (4,70)	.116 (2,95)
12SWS0393	SWS 393	.380 (9,65)	.400 (10,16)	.032 (0,81)	.200 (5,08)	.132 (3,35)
12SWS0394	SWS 394	.226 (5,74)	.276 (7,01)	.030 (0,76)	.236 (5,99)	.177 (4,50)
12SWS0395	SWS 395	.025 (0,64)	.250 (6,35)	.031 (0,79)	.122 (3,10)	.093 (2,36)
12SWS0396	SWS 396	.040 (1,02)	.250 (6,35)	.047 (1,19)	.140 (3,56)	.102 (2,59)
12SWS0397	SWS 397	.032 (0,81)	.250 (6,35)	.063 (1,60)	.150 (3,81)	.116 (2,95)
12SWS0398	SWS 398	.296 (7,52)	.290 (7,37)	.047 (1,19)	.170 (4,32)	.140 (3,56)
12SWS0399	SWS 399	.050 (1,27)	.250 (6,35)	.031 (0,79)	.185 (4,70)	.120 (3,02)
12SWS0400	SWS 400	3/32 (2,38)	.235 (5,97)	3/64 (1,19)	.141 (3,58)	.115 (2,92)
12SWS0401	SWS 401	1/4 (6,35)	.235 (5,97)	3/64 (1,19)	.145 (3,68)	.115 (2,92)
12SWS0402	SWS 402	3/64 (1,19)	.240 (6,09)	1/16 (1,59)	.138 (3,50)	.114 (2,89)
12SWS0403	SWS 403	1/16 (1,59)	.312 (7,93)	1/16 (1,59)	.149 (3,79)	.115 (2,92)
12SWS0404	SWS 404	3/32 (2,38)	.312 (7,93)	1/16 (1,59)	.149 (3,79)	.115 (2,92)
12SWS0405	SWS 405	1/64 (0,41)	.250 (6,35)	3/64 (1,19)	.124 (3,15)	.111 (2,82)
12SWS0406	SWS 406	1/32 (0,79)	.252 (6,40)	1/32 (0,79)	.186 (4,72)	.140 (3,56)
12SWS0407	SWS 407	1/32 (0,79)	.250 (6,35)	1/32 (0,79)	.186 (4,72)	.139 (3,53)
12SWS0408	SWS 408	.250 (6,35)	.235 (5,97)	.032 (0,81)	.120 (3,05)	.090 (2,29)
12SWS0409	SWS 409	1/8 (3,18)	.250 (6,35)	1/32 (0,79)	.195 (4,95)	.130 (3,30)
12SWS0410	SWS 410	1/32 (0,79)	.250 (6,35)	3/64 (1,19)	.114 (2,90)	.100 (2,54)
12SWS0411	SWS 411	1/16 (1,59)	.250 (6,35)	1/32 (0,79)	.143 (3,63)	.115 (2,92)
12SWS0412	SWS 412	1/16 (1,59)	.250 (6,35)	1/32 (0,79)	.169 (4,29)	.102 (2,59)
12SWS0413	SWS 413	3/32 (2,38)	.250 (6,35)	3/64 (1,19)	.114 (2,90)	.100 (2,54)
12SWS0414	SWS 414	1/8 (3,18)	.281 (7,14)	3/32 (2,38)	.158 (4,01)	.093 (2,36)
12SWS0415	SWS 415	3/16 (4,76)	.293 (7,44)	3/64 (1,19)	.218 (5,53)	.138 (3,51)
12SWS0416	SWS 416	11/64 (4,37)	.250 (6,35)	3/64 (1,19)	.186 (4,72)	.126 (3,20)
12SWS0417	SWS 417	1/64 (0,41)	.310 (7,87)	1/16 (1,59)	.183 (4,65)	.139 (3,53)
12SWS0418	SWS 418	1/64 (0,41)	.312 (7,93)	1/16 (1,59)	.187 (4,75)	.115 (2,92)
12SWS0419	SWS 419	1/32 (0,79)	.312 (7,93)	1/32 (0,79)	.185 (4,70)	.140 (3,56)
12SWS0420	SWS 420	1/16 (1,59)	.312 (7,93)	1/16 (1,59)	.170 (4,32)	.120 (3,05)



WASHERS, SHOULDER WASHERS & SCREW INSULATORS

SHOULDER WASHERS

Molded in **Natural Nylon 6/6**

SECTION
IV

Nylon Shoulder Washers are suitable for a large variety of insulation and mechanical applications.

- ▶ THEY INSULATE
- ▶ REDUCE VIBRATION
- ▶ ACT AS SPACERS AND GUIDES
- ▶ STRONG AND CORROSION RESISTANT
- ▶ CAN BE USED AS SEAL IN SOME APPLICATIONS

ITEM NUMBER	DESCRIPTION	SHANK LENGTH	OD	THICKNESS	SHANK OD	ID
12SWS0421	SWS 421	3/64 (1,19)	.312 (7,93)	1/16 (1,59)	.170 (4,32)	.127 (3,23)
12SWS0422	SWS 422	1/8 (3,18)	.312 (7,93)	3/64 (1,19)	.234 (5,94)	.144 (3,66)
12SWS0423	SWS 423	1/64 (0,41)	.250 (6,35)	1/32 (0,79)	.150 (3,81)	.116 (2,95)
12SWS0424	SWS 424	7/32 (5,55)	.295 (7,49)	1/32 (0,79)	.234 (5,94)	.140 (3,56)
12SWS0425	SWS 425	1/32 (0,79)	.312 (7,93)	1/16 (1,59)	.250 (6,35)	.196 (4,98)
12SWS0426	SWS 426	11/64 (4,37)	.250 (6,35)	3/64 (1,19)	.145 (3,68)	.115 (2,92)
12SWS0427	SWS 427	3/64 (1,19)	.250 (6,35)	1/32 (0,79)	.185 (4,70)	.116 (2,95)
12SWS0428	SWS 428	7/64 (2,77)	.242 (6,15)	3/64 (1,19)	.140 (3,56)	.115 (2,92)
12SWS0429	SWS 429	9/64 (3,58)	.250 (6,35)	3/64 (1,19)	.145 (3,68)	.115 (2,92)
12SWS0430	SWS 430	3/16 (4,76)	.315 (8,00)	1/16 (1,59)	.250 (6,35)	.156 (3,96)
12SWS0431	SWS 431	3/32 (2,38)	.240 (6,10)	1/32 (0,79)	.185 (4,70)	.125 (3,18)
12SWS0432	SWS 432	3/64 (1,19)	.250 (6,35)	3/64 (1,19)	.143 (3,63)	.113 (2,87)
12SWS0433	SWS 433	7/64 (2,77)	.250 (6,35)	3/64 (1,19)	.145 (3,68)	.115 (2,92)
12SWS0434	SWS 434	1/16 (1,59)	.312 (7,93)	3/64 (1,19)	.170 (4,32)	.140 (3,56)
12SWS0435	SWS 435	3/64 (1,19)	.250 (6,35)	1/16 (1,59)	.185 (4,70)	.116 (2,95)
12SWS0436	SWS 436	1/32 (0,79)	.240 (6,10)	3/64 (1,19)	.139 (3,53)	.115 (2,92)
12SWS0437	SWS 437	1/32 (0,79)	.265 (6,73)	1/32 (0,79)	.157 (3,99)	.126 (3,20)
12SWS0438	SWS 438	1/32 (0,79)	.312 (7,93)	1/16 (1,59)	.187 (4,75)	.141 (3,58)
12SWS0439	SWS 439	1/16 (1,59)	.250 (6,35)	3/64 (1,19)	.138 (3,50)	.120 (3,05)
12SWS0440	SWS 440	5/16 (7,94)	.312 (7,93)	1/32 (0,79)	.154 (3,91)	.130 (3,30)
12SWS0441	SWS 441	3/16 (4,76)	.315 (8,00)	1/32 (0,79)	.234 (5,94)	.184 (4,67)
12SWS0442	SWS 442	7/32 (5,54)	.296 (7,52)	1/32 (0,79)	.235 (5,97)	.135 (3,43)
12SWS0443	SWS 443	.156 (3,96)	.252 (6,40)	.047 (1,19)	.140 (3,56)	.115 (2,92)
12SWS0444	SWS 444	1/16 (1,59)	.300 (7,62)	3/64 (1,19)	.194 (4,93)	.160 (4,06)
12SWS0445	SWS 445	1/32 (0,79)	.313 (7,95)	1/32 (0,79)	.175 (4,45)	.143 (3,63)
12SWS0446	SWS 446	1/64 (0,41)	.312 (7,93)	3/64 (1,19)	.160 (4,06)	.097 (2,46)
12SWS0448	SWS 448	3/32 (2,38)	.312 (7,93)	3/64 (1,19)	.187 (4,75)	.128 (3,25)
12SWS0449	SWS 449	1/32 (0,79)	.313 (7,95)	1/32 (0,79)	.219 (5,56)	.124 (3,15)
12SWS0450	SWS 450	1/16 (1,59)	.312 (7,93)	3/64 (1,19)	.234 (5,94)	.144 (3,66)
12SWS0451	SWS 451	1/32 (0,79)	.315 (8,00)	.030 (0,76)	.150 (3,81)	.115 (2,92)
12SWS0452	SWS 452	1/32 (0,79)	.312 (7,93)	3/64 (1,19)	.203 (5,16)	.120 (3,05)
12SWS0453	SWS 453	.027 (0,69)	.312 (7,93)	.035 (0,89)	.187 (4,75)	.140 (3,56)
12SWS0454	SWS 454	1/32 (0,79)	.313 (7,95)	1/32 (0,79)	.219 (5,56)	.136 (3,45)
12SWS0455	SWS 455	3/64 (1,19)	.315 (8,00)	1/32 (0,79)	.185 (4,70)	.126 (3,20)
12SWS0456	SWS 456	3/64 (1,19)	.250 (6,35)	3/64 (1,19)	.156 (3,96)	.115 (2,92)
12SWS0457	SWS 457	.031 (0,79)	.250 (6,35)	.031 (0,79)	.187 (4,75)	.120 (3,05)
12SWS0458	SWS 458	.078 (1,98)	.312 (7,92)	.031 (0,79)	.185 (4,70)	.128 (3,25)
12SWS0459	SWS 459	15/64 (5,94)	.291 (7,39)	1/16 (1,59)	.154 (3,91)	.120 (3,05)
12SWS0460	SWS 460	.125 (3,18)	.290 (7,37)	.047 (1,19)	.170 (4,32)	.140 (3,56)
12SWS0462	SWS 462	.031 (0,79)	.312 (7,93)	.063 (1,60)	.187 (4,75)	.123 (3,12)
12SWS0463	SWS 463	.050 (1,27)	.312 (7,93)	.046 (1,17)	.229 (5,82)	.163 (4,13)
12SWS0464	SWS 464	19/64 (7,52)	.250 (6,35)	3/64 (1,19)	.145 (3,68)	.115 (2,92)
12SWS0465	SWS 465	.060 (1,52)	.312 (7,93)	.030 (0,76)	.189 (4,80)	.144 (3,66)
12SWS0466	SWS 466	.025 (0,64)	.307 (7,80)	.035 (0,89)	.154 (3,91)	.093 (2,36)
12SWS0467	SWS 467	.062 (1,57)	.312 (7,93)	.063 (1,60)	.126 (3,20)	.091 (2,31)
12SWS0468	SWS 468	.250 (6,35)	.312 (7,93)	.060 (1,52)	.210 (5,33)	.142 (3,61)

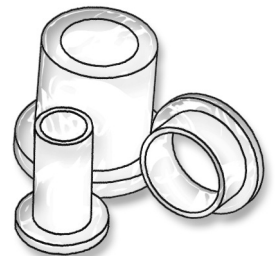
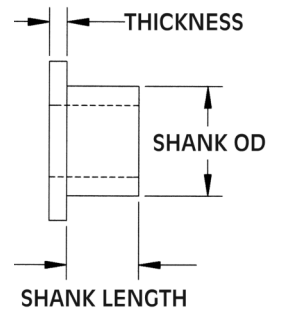
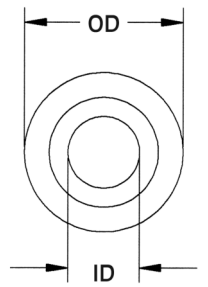

WASHERS, SHOULDER WASHERS & SCREW INSULATORS

SECTION IV

SHOULDER WASHERS

Molded in **Natural Nylon 6/6**

Nylon Shoulder Washers are suitable for a large variety of insulation and mechanical applications.

- ▶ THEY INSULATE
- ▶ REDUCE VIBRATION
- ▶ ACT AS SPACERS AND GUIDES
- ▶ STRONG AND CORROSION RESISTANT
- ▶ CAN BE USED AS SEAL IN SOME APPLICATIONS

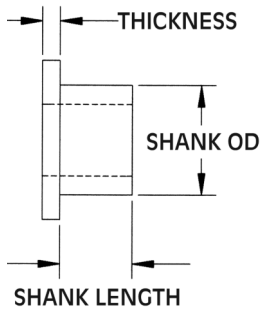
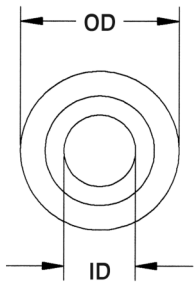

ITEM NUMBER	DESCRIPTION	SHANK LENGTH	OD	THICKNESS	SHANK OD	ID
12SWS0469	SWS 469	.122 (3,10)	.388 (9,85)	.187 (4,75)	.207 (5,26)	.160 (4,06)
12SWS0470	SWS 470	.165 (4,19)	.290 (7,37)	.047 (1,19)	.200 (5,08)	.145 (3,68)
12SWS0472	SWS 472	.027 (0,69)	.316 (8,03)	.096 (2,44)	.181 (4,60)	.150 (3,81)
12SWS0473	SWS 473	.600 (15,24)	.290 (7,39)	.047 (1,19)	.210 (5,33)	.140 (3,56)
12SWS0474	SWS 474	.312 (7,92)	.312 (7,92)	.058 (1,47)	.185 (4,70)	.125 (3,18)
12SWS0475	SWS 475	.100 (2,54)	.312 (7,93)	.045 (1,14)	.150 (3,81)	.114 (2,90)
12SWS0476	SWS 476	.052 (1,32)	.300 (7,62)	.035 (0,89)	.087 (2,21)	.055 (1,40)
12SWS0477	SWS 477	.067 (1,70)	.308 (7,82)	.045 (1,14)	.183 (4,65)	.132 (3,35)
12SWS0478	SWS 478	.750 (19,05)	.325 (8,26)	.047 (1,19)	.220 (5,59)	.140 (3,56)
12SWS0479	SWS 479	.187 (4,75)	5/16 (7,94)	.062 (1,58)	.172 (4,37)	.147 (3,73)
12SWS0480	SWS 480	.100 (2,54)	.310 (7,87)	.037 (0,94)	.242 (6,15)	.164 (4,17)
12SWS0482	SWS 482	.188 (4,76)	.375 (9,52)	.045 (1,14)	.250 (6,35)	.165 (4,19)
12SWS0601	SWS 601	1/4 (6,35)	.290 (7,37)	3/64 (1,19)	.170 (4,32)	.140 (3,56)
12SWS0602	SWS 602	1/32 (0,79)	.330 (8,38)	1/16 (1,59)	.206 (5,23)	.141 (3,58)
12SWS0603	SWS 603	.062 (1,57)	.300 (7,62)	.050 (1,27)	.180 (4,57)	.150 (3,81)
12SWS0604	SWS 604	.125 (3,18)	.300 (7,62)	.047 (1,19)	.194 (4,93)	.160 (4,06)
12SWS0605	SWS 605	3/64 (1,19)	.328 (8,33)	3/64 (1,19)	.218 (5,54)	.146 (3,71)
12SWS0606	SWS 606	3/64 (1,19)	.340 (8,64)	5/64 (1,98)	.250 (6,35)	.140 (3,56)
12SWS0607	SWS 607	1/16 (1,59)	.292 (7,42)	1/16 (1,59)	.215 (5,46)	.093 (2,36)
12SWS0608	SWS 608	3/64 (1,19)	.290 (7,37)	3/64 (1,19)	.170 (4,32)	.140 (3,56)
12SWS0609	SWS 609	3/64 (1,19)	.312 (7,93)	1/32 (0,79)	.185 (4,70)	.116 (2,95)
12SWS0610	SWS 610	1/16 (1,59)	.348 (8,83)	1/32 (0,79)	.290 (7,36)	.256 (6,50)
12SWS0611	SWS 611	.085 (2,15)	.201 (5,10)	.040 (1,01)	.166 (4,21)	.108 (2,74)
12SWS0612	SWS 612	3/32 (2,38)	.316 (8,03)	3/64 (1,19)	.158 (4,01)	.116 (2,95)
12SWS0613	SWS 613	.030 (0,76)	.375 (9,52)	.045 (1,14)	.160 (4,06)	.120 (3,04)
12SWS0614	SWS 614	1/32 (0,79)	.324 (8,23)	1/16 (1,59)	.204 (5,18)	.140 (3,56)
12SWS0615	SWS 615	.065 (1,65)	.320 (8,13)	.050 (1,27)	.182 (4,62)	.141 (3,58)
12SWS0616	SWS 616	.126 (3,20)	.320 (8,13)	.039 (0,99)	.250 (6,35)	.218 (5,54)
12SWS0621	SWS 621	3/32 (2,38)	.340 (8,64)	1/16 (1,59)	.220 (5,59)	.175 (4,45)
12SWS0622	SWS 622	.387 (9,83)	.372 (9,45)	.062 (1,57)	.201 (5,11)	.176 (4,47)
12SWS0623	SWS 623	.074 (1,88)	.325 (8,25)	.076 (1,93)	.219 (5,57)	.170 (4,32)
12SWS0624	SWS 624	.050 (1,27)	.312 (7,94)	.031 (0,79)	.211 (5,36)	.176 (4,47)
12SWS0625	SWS 625	.373 (9,47)	.340 (8,64)	.063 (1,60)	.223 (5,66)	.159 (4,04)
12SWS0627	SWS 627	.250 (6,35)	.365 (9,27)	.062 (1,57)	.203 (5,16)	.170 (4,32)
12SWS0628	SWS 628	3/8 (9,53)	.345 (8,76)	1/16 (1,59)	.205 (5,21)	.173 (4,39)
12SWS0629	SWS 629	3/64 (1,19)	.345 (8,76)	1/16 (1,59)	.209 (5,30)	.171 (4,34)
12SWS0630	SWS 630	13/64 (5,16)	.368 (9,34)	5/64 (1,98)	.146 (3,70)	.115 (2,92)
12SWS0631	SWS 631	.500 (12,70)	.250 (6,35)	.035 (0,89)	.187 (4,75)	.070 (1,78)
12SWS0632	SWS 632	1/16 (1,59)	.349 (8,87)	3/64 (1,19)	.248 (6,30)	.140 (3,56)
12SWS0633	SWS 633	.060 (1,52)	.349 (8,87)	.050 (1,27)	.260 (6,60)	.133 (3,38)
12SWS0634	SWS 634	11/64 (4,37)	.350 (8,89)	1/64 (0,41)	.300 (7,62)	.112 (2,84)
12SWS0635	SWS 635	.070 (1,78)	.375 (9,53)	.04 (1,02)	.190 (4,83)	.125 (3,18)
12SWS0636	SWS 636	.120 (3,05)	.344 (8,74)	.063 (1,60)	.235 (5,97)	.175 (4,45)
12SWS0637	SWS 637	.093 (2,36)	.344 (8,74)	.063 (1,60)	.205 (5,21)	.173 (4,39)
12SWS0638	SWS 638	.074 (1,88)	.438 (11,13)	.076 (1,93)	.225 (5,72)	.166 (4,22)
12SWS0639	SWS 639	.190 (4,83)	.343 (8,71)	.060 (1,52)	.197 (5,00)	.176 (4,47)



WASHERS, SHOULDER WASHERS & SCREW INSULATORS

SHOULDER WASHERS

Molded in **Natural Nylon 6/6**

SECTION
IV

Nylon Shoulder Washers are suitable for a large variety of insulation and mechanical applications.

▶ THEY INSULATE ▶ REDUCE VIBRATION ▶ ACT AS SPACERS AND GUIDES ▶ STRONG AND CORROSION RESISTANT ▶ CAN BE USED AS SEAL IN SOME APPLICATIONS

ITEM NUMBER	DESCRIPTION	SHANK LENGTH	OD	THICKNESS	SHANK OD	ID
12SWS0640	SWS 640	.438 (11,12)	.344 (8,73)	.063 (1,60)	.205 (5,20)	.073 (4,39)
12SWS0796	SWS 796	.055 (1,40)	.313 (7,95)	.085 (2,16)	.187 (4,75)	.144 (3,66)
12SWS0798	SWS 798	.085 (2,16)	.344 (8,74)	.063 (1,60)	.235 (5,97)	.175 (4,45)
12SWS0799	SWS 799	3/64 (1,19)	.344 (8,74)	7/64 (2,77)	.189 (4,80)	.141 (3,58)
12SWS0800	SWS 800	9/64 (3,58)	.344 (8,74)	1/16 (1,59)	.210 (5,33)	.170 (4,32)
12SWS0801	SWS 801	3/8 (9,53)	.344 (8,74)	1/16 (1,59)	.205 (5,21)	.173 (4,39)
12SWS0802	SWS 802	1/16 (1,59)	.375 (9,53)	1/32 (0,79)	.195 (4,95)	.171 (4,34)
12SWS0803	SWS 803	13/32 (10,32)	.510 (12,95)	1/16 (1,59)	.250 (6,35)	.171 (4,34)
12SWS0804	SWS 804	.177 (4,50)	.355 (9,02)	.020 (0,51)	.315 (8,00)	.236 (5,99)
12SWS0805	SWS 805	.283 (7,19)	.370 (9,40)	.067 (1,70)	.242 (6,15)	.195 (4,95)
12SWS0806	SWS 806	.250 (6,35)	.344 (8,74)	.032 (0,81)	.205 (5,21)	.173 (4,39)
12SWS0807	SWS 807	.046 (1,17)	.359 (9,12)	.060 (1,52)	.300 (7,62)	.227 (5,77)
12SWS0808	SWS 808	1/8 (3,18)	.375 (9,53)	1/16 (1,59)	.280 (7,11)	.201 (5,10)
12SWS0809	SWS 809	5/32 (3,97)	.378 (9,60)	5/64 (1,98)	.194 (4,92)	.116 (2,94)
12SWS0810	SWS 810	1/32 (0,79)	.375 (9,53)	1/16 (1,59)	.250 (6,35)	.171 (4,34)
12SWS0811	SWS 811	3/64 (1,19)	.375 (9,53)	3/64 (1,19)	.245 (6,22)	.192 (4,88)
12SWS0812	SWS 812	3/32 (2,38)	.375 (9,53)	1/32 (0,79)	.260 (6,60)	.220 (5,59)
12SWS0813	SWS 813	7/64 (2,77)	.375 (9,53)	3/64 (1,19)	.195 (4,95)	.136 (3,45)
12SWS0814	SWS 814	3/64 (1,19)	.375 (9,53)	5/64 (1,98)	.244 (6,20)	.150 (3,81)
12SWS0815	SWS 815	3/32 (2,38)	.375 (9,53)	1/32 (0,79)	.185 (4,70)	.140 (3,56)
12SWS0816	SWS 816	1/32 (0,79)	.375 (9,53)	1/32 (0,79)	.250 (6,35)	.169 (4,29)
12SWS0817	SWS 817	3/64 (1,19)	.375 (9,53)	1/16 (1,59)	.218 (5,54)	.140 (3,56)
12SWS0818	SWS 818	1/32 (0,79)	.375 (9,53)	1/16 (1,59)	.246 (6,25)	.167 (4,24)
12SWS0819	SWS 819	1/16 (1,59)	.437 (11,10)	1/16 (1,59)	.313 (7,95)	.188 (4,78)
12SWS0820	SWS 820	1/32 (0,79)	.375 (9,53)	1/16 (1,59)	.185 (4,70)	.140 (3,56)
12SWS0821	SWS 821	1/32 (0,79)	.381 (9,68)	1/16 (1,59)	.308 (7,82)	.196 (4,98)
12SWS0822	SWS 822	1/32 (0,79)	.374 (9,50)	1/32 (0,79)	.246 (6,24)	.141 (3,58)
12SWS0823	SWS 823	.099 (2,51)	.375 (9,53)	.040 (1,02)	.250 (6,35)	.171 (4,34)
12SWS0824	SWS 824	.05 (1,27)	3/8 (9,53)	.06 (1,52)	.245 (6,22)	.140 (3,56)
12SWS0825	SWS 825	.060 (1,52)	.375 (9,53)	.030 (0,76)	.245 (6,22)	.145 (3,68)
12SWS0826	SWS 826	.062 (1,57)	.500 (12,70)	1/16 (1,59)	.308 (7,82)	.196 (4,98)
12SWS0827	SWS 827	.046 (1,17)	.375 (9,53)	.040 (1,02)	.250 (6,35)	.171 (4,34)
12SWS0828	SWS 828	.125 (3,18)	.380 (9,65)	.065 (1,65)	.254 (6,45)	.196 (4,98)
12SWS0829	SWS 829	1/8 (3,18)	.370 (9,40)	.110 (2,79)	.307 (7,80)	.255 (6,48)
12SWS0830	SWS 830	.032 (0,81)	.375 (9,53)	.062 (1,57)	.187 (4,75)	.147 (3,73)
12SWS0831	SWS 831	.250 (6,35)	.375 (9,53)	.040 (1,02)	.250 (6,35)	.171 (4,34)
12SWS0832	SWS 832	.043 (1,09)	.375 (9,53)	.035 (0,76)	.257 (6,53)	.193 (4,90)
12SWS0833	SWS 833	.050 (1,27)	.375 (9,53)	.031 (0,79)	.243 (6,17)	.199 (5,05)
12SWS0834	SWS 834	.015 (0,38)	.375 (9,53)	.057 (1,45)	.304 (7,72)	.200 (5,08)
12SWS0835	SWS 835	.050 (1,27)	.377 (9,58)	.050 (1,27)	.245 (6,22)	.155 (3,94)
12SWS0836	SWS 836	.030 (0,76)	.375 (9,53)	.063 (1,60)	.250 (6,35)	.174 (4,42)
12SWS0837	SWS 837	.031 (0,79)	.375 (9,53)	.062 (1,57)	.187 (4,75)	.093 (2,36)
12SWS0838	SWS 838	.180 (4,57)	.350 (8,89)	.067 (1,70)	.240 (6,10)	.188 (4,78)
12SWS0839	SWS 839	.050 (1,27)	.385 (9,78)	.030 (0,76)	.250 (6,35)	.169 (4,29)
12SWS0840	SWS 840	13/64 (5,16)	.370 (9,40)	5/64 (1,98)	.145 (3,68)	.115 (2,92)
12SWS0841	SWS 841	1/8" (3,17)	3/8" (9,52)	.035 (0,89)	.242 (6,15)	.185 (4,70)

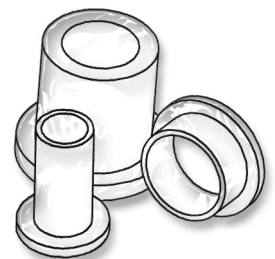
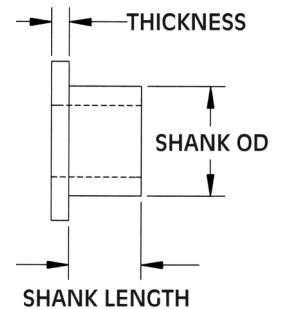
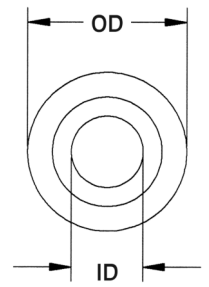

WASHERS, SHOULDER WASHERS & SCREW INSULATORS

SECTION IV

SHOULDER WASHERS

Molded in **Natural Nylon 6/6**

Nylon Shoulder Washers are suitable for a large variety of insulation and mechanical applications.

► THEY INSULATE ► REDUCE VIBRATION ► ACT AS SPACERS AND GUIDES ► STRONG AND CORROSION RESISTANT ► CAN BE USED AS SEAL IN SOME APPLICATIONS

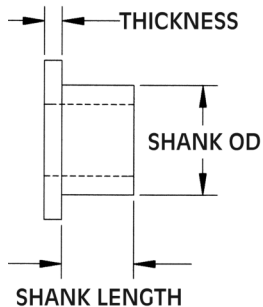
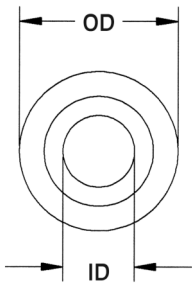

ITEM NUMBER	DESCRIPTION	SHANK LENGTH	OD	THICKNESS	SHANK OD	ID
12SWS0842	SWS 842	5/64 (1,98)	.375 (9,53)	7/32 (5,55)	.199 (5,05)	.140 (3,56)
12SWS0843	SWS 843	.072 (1,83)	.385 (9,78)	.051 (1,30)	.250 (6,35)	.137 (3,48)
12SWS0844	SWS 844	3/64 (1,19)	.381 (9,68)	1/16 (1,59)	.185 (4,70)	.140 (3,56)
12SWS0845	SWS 845	.346 (8,79)	.370 (9,40)	.031 (0,79)	.242 (6,15)	.180 (4,57)
12SWS0846	SWS 846	1/16 (1,59)	.375 (9,53)	3/32 (2,38)	.250 (6,35)	.140 (3,56)
12SWS0847	SWS 847	.213 (5,14)	.375 (9,53)	1/16 (1,59)	.250 (6,35)	.198 (5,02)
12SWS0848	SWS 848	1/32 (0,79)	.385 (9,78)	1/16 (1,59)	.240 (6,10)	.145 (3,68)
12SWS0849	SWS 849	.060 (1,52)	.375 (9,53)	.030 (0,76)	.312 (7,92)	.253 (6,43)
12SWS0850	SWS 850	1/16 (1,59)	.375 (9,53)	3/32 (2,38)	.250 (6,35)	.138 (3,51)
12SWS0851	SWS 851	.155 (3,94)	.370 (9,40)	.050 (1,27)	.245 (6,22)	.145 (3,68)
12SWS0852	SWS 852	3/32 (2,38)	.375 (9,53)	1/16 (1,59)	.248 (6,30)	.136 (3,45)
12SWS0853	SWS 853	.030 (0,76)	.380 (9,65)	.066 (1,68)	.250 (6,35)	.190 (4,83)
12SWS0854	SWS 854	3/64 (1,19)	.375 (9,53)	1/16 (1,59)	.240 (6,10)	.194 (4,93)
12SWS0855	SWS 855	7/64 (2,77)	.375 (9,53)	1/16 (1,59)	.240 (6,10)	.138 (3,51)
12SWS0856	SWS 856	3/32 (2,38)	.375 (9,53)	1/64 (0,38)	.185 (4,70)	.140 (3,56)
12SWS0857	SWS 857	5/32 (3,97)	.375 (9,53)	5/64 (1,98)	.193 (4,90)	.116 (2,95)
12SWS0858	SWS 858	1/16 (1,59)	.375 (9,53)	1/16 (1,59)	.250 (6,35)	.145 (3,68)
12SWS0859	SWS 859	9/64 (3,58)	.375 (9,53)	1/32 (0,79)	.245 (6,22)	.187 (4,75)
12SWS0860	SWS 860	13/64 (5,16)	.380 (9,65)	1/16 (1,59)	.220 (5,59)	.148 (3,76)
12SWS0861	SWS 861	1/8 (3,18)	.378 (9,60)	1/32 (0,79)	.255 (6,48)	.116 (2,94)
12SWS0862	SWS 862	3/16 (4,76)	.390 (9,91)	5/64 (1,98)	.287 (7,29)	.196 (4,98)
12SWS0863	SWS 863	5/64 (1,98)	.390 (9,91)	5/64 (1,98)	.313 (7,95)	.203 (5,16)
12SWS0864	SWS 864	7/64 (2,77)	.395 (10,03)	5/64 (1,98)	.299 (7,59)	.230 (5,84)
12SWS0865	SWS 865	.055 (1,44)	.380 (9,65)	.065 (1,65)	.254 (6,45)	.196 (4,98)
12SWS0867	SWS 867	.046 (1,17)	.375 (9,53)	.040 (1,02)	.214 (5,44)	.141 (3,58)
12SWS0868	SWS 868	.031 (0,79)	.375 (9,53)	.062 (1,57)	.312 (7,92)	.253 (6,43)
12SWS0869	SWS 869	.207 (5,26)	.390 (9,91)	.062 (1,57)	.348 (8,84)	.312 (7,92)
12SWS0870	SWS 870	1/8 (3,18)	.433 (10,99)	1/16 (1,59)	.312 (7,92)	.199 (5,05)
12SWS0871	SWS 871	.130 (3,30)	.390 (9,91)	.062 (1,57)	.260 (6,60)	.200 (5,08)
12SWS0872	SWS 872	.160 (4,06)	27/64 (10,72)	.050 (1,27)	9/32 (7,15)	.200 (5,08)
12SWS0873	SWS 873	.126 (3,20)	.394 (10,01)	.039 (0,99)	.256 (6,50)	.221 (5,61)
12SWS0874	SWS 874	.139 (3,53)	.390 (9,91)	.025 (0,63)	.303 (7,70)	.223 (5,66)
12SWS0875	SWS 875	.300 (7,62)	.375 (9,53)	.050 (1,27)	.253 (6,43)	.125 (3,18)
12SWS0876	SWS 876	.075 (1,91)	.390 (9,91)	.062 (1,57)	.260 (6,60)	.200 (5,08)
12SWS0877	SWS 877	.312 (7,92)	.390 (9,91)	.055 (1,40)	.281 (7,14)	.171 (4,34)
12SWS0878	SWS 878	.126 (3,20)	.394 (10,01)	.030 (0,76)	.256 (6,50)	.221 (5,61)
12SWS0879	SWS 879	.380 (9,65)	.385 (9,78)	.060 (1,52)	.236 (5,99)	.195 (4,95)
12SWS0880	SWS 880	1/8 (3,18)	.400 (10,16)	1/8 (3,18)	.275 (6,99)	.140 (3,56)
12SWS0881	SWS 881	.187 (4,75)	.312 (7,92)	.125 (3,18)	.250 (6,35)	.115 (2,92)
12SWS0882	SWS 882	9/32 (7,14)	.470 (11,93)	5/64 (1,98)	.312 (7,92)	.140 (3,56)
12SWS0883	SWS 883	.500 (12,70)	.407 (10,34)	.062 (1,57)	.260 (6,60)	.180 (4,57)
12SWS0884	SWS 884	.126 (3,20)	.394 (10,01)	.030 (0,76)	.275 (6,99)	.221 (5,61)
12SWS0885	SWS 885	.100 (1,54)	.400 (10,16)	1/8 (3,18)	.275 (6,99)	.140 (3,56)
12SWS0886	SWS 886	.138 (3,51)	.500 (12,70)	.062 (1,57)	.312 (7,92)	.140 (3,56)
12SWS0887	SWS 887	.187 (4,75)	.408 (10,36)	.062 (1,57)	.240 (6,10)	.197 (5,00)
12SWS0888	SWS 888	3/64 (1,19)	.400 (10,16)	3/64 (1,19)	.243 (6,17)	.156 (3,96)
12SWS0889	SWS 889	.420 (10,67)	.450 (11,43)	.125 (3,18)	.250 (6,35)	.195 (4,95)
12SWS0890	SWS 890	3/64 (1,19)	.415 (10,54)	5/32 (3,97)	.243 (6,17)	.141 (3,58)



WASHERS, SHOULDER WASHERS & SCREW INSULATORS

SHOULDER WASHERS

Molded in **Natural Nylon 6/6**

SECTION
IV

Nylon Shoulder Washers are suitable for a large variety of insulation and mechanical applications.

▶ THEY INSULATE ▶ REDUCE VIBRATION ▶ ACT AS SPACERS AND GUIDES ▶ STRONG AND CORROSION RESISTANT ▶ CAN BE USED AS SEAL IN SOME APPLICATIONS

ITEM NUMBER	DESCRIPTION	SHANK LENGTH	OD	THICKNESS	SHANK OD	ID
12SWS0891	SWS 891	.058 (1,47)	.445 (11,30)	.077 (1,96)	.343 (8,71)	.308 (7,82)
12SWS0892	SWS 892	.095 (2,41)	.360 (9,14)	.040 (1,02)	.250 (6,35)	.150 (3,81)
12SWS0893	SWS 893	.075 (1,91)	.595 (15,11)	.062 (1,57)	.273 (6,93)	.170 (4,32)
12SWS0894	SWS 894	1/16 (1,59)	.418 (10,62)	7/64 (2,77)	.243 (6,17)	.141 (3,58)
12SWS0895	SWS 895	.050 (1,27)	.437 (11,10)	.062 (1,57)	.274 (6,96)	.199 (5,05)
12SWS0896	SWS 896	3/16 (4,76)	.408 (10,36)	1/16 (1,59)	.240 (6,10)	.220 (5,59)
12SWS0897	SWS 897	.315 (8,00)	.433 (11,00)	.079 (2,01)	.310 (7,87)	.202 (5,13)
12SWS0898	SWS 898	.050 (1,27)	.438 (11,13)	.062 (1,57)	.350 (8,89)	.125 (3,18)
12SWS0900	SWS 900	1/32 (0,79)	.428 (10,87)	1/16 (1,59)	.245 (6,22)	.156 (3,96)
12SWS0901	SWS 901	.093 (2,36)	.437 (11,10)	.040 (1,02)	.375 (9,53)	.194 (4,93)
12SWS0902	SWS 902	1/32 (0,79)	.437 (11,10)	1/16 (1,59)	.245 (6,22)	.156 (3,96)
12SWS0903	SWS 903	.115 (2,92)	.432 (10,97)	.065 (1,65)	.256 (6,50)	.196 (4,98)
12SWS0904	SWS 904	3/8 (9,53)	.437 (11,10)	1/16 (1,59)	.282 (7,16)	.225 (5,72)
12SWS0905	SWS 905	1/16 (1,59)	.425 (10,78)	1/16 (1,59)	.310 (7,87)	.250 (6,35)
12SWS0906	SWS 906	.035 (0,89)	.625 (15,87)	.050 (1,27)	.427 (10,84)	.170 (4,32)
12SWS0907	SWS 907	.026 (0,66)	.438 (11,13)	.094 (2,39)	.307 (7,80)	.253 (6,43)
12SWS0908	SWS 908	3/32 (2,38)	.438 (11,13)	1/32 (0,79)	.267 (6,78)	.203 (5,16)
12SWS0909	SWS 909	13/32 (10,32)	.493 (12,52)	3/32 (2,38)	.376 (9,55)	.176 (4,47)
12SWS0910	SWS 910	.070 (1,78)	.438 (11,13)	.048 (1,22)	.285 (7,24)	.191 (4,85)
12SWS0911	SWS 911	.048 (1,22)	.428 (10,87)	.155 (3,94)	.261 (6,63)	.163 (4,14)
12SWS0912	SWS 912	9/64 (3,58)	.432 (10,97)	1/32 (0,79)	.303 (7,70)	.196 (4,98)
12SWS0913	SWS 913	.027 (0,69)	.375 (9,53)	.031 (0,79)	.216 (5,49)	.120 (3,05)
12SWS0914	SWS 914	.043 (1,09)	.440 (11,18)	.094 (2,39)	.312 (7,92)	.193 (4,90)
12SWS0915	SWS 915	.138 (3,51)	.413 (10,49)	.315 (8,00)	.244 (6,20)	.217 (5,51)
12SWS0916	SWS 916	3/16 (4,76)	.743 (18,87)	1/16 (1,59)	.437 (11,10)	.376 (9,55)
12SWS0917	SWS 917	3/64 (1,19)	.428 (10,87)	1/8 (3,18)	.350 (8,89)	.308 (7,82)
12SWS0918	SWS 918	3/64 (1,19)	.450 (11,43)	1/64 (0,41)	.310 (7,87)	.230 (5,84)
12SWS0919	SWS 919	.060 (1,52)	.460 (11,68)	.030 (0,76)	.370 (9,40)	.260 (6,60)
12SWS0920	SWS 920	.138 (3,51)	.413 (10,49)	.118 (3,00)	.244 (6,20)	.217 (5,51)
12SWS0921	SWS 921	.236 (5,99)	.480 (12,19)	.079 (2,01)	.315 (8,00)	.240 (6,10)
12SWS0922	SWS 922	.282 (7,16)	.450 (11,43)	.047 (1,19)	.170 (4,32)	.140 (3,56)
12SWS0923	SWS 923	.190 (4,83)	.450 (11,43)	.063 (1,60)	.215 (5,46)	.190 (4,83)
12SWS0924	SWS 924	1/32" (0,79)	.375 (9,53)	1/16" (1,57)	.248 (6,30)	.130 (3,30)
12SWS0925	SWS 925	3/64 (1,19)	.468 (11,89)	1/16 (1,59)	.248 (6,30)	.140 (3,56)
12SWS0926	SWS 926	11/16 (17,53)	.498 (12,64)	1/16 (1,59)	.375 (9,53)	.254 (6,45)
12SWS0927	SWS 927	.404 (10,26)	.480 (12,19)	.079 (2,01)	.315 (8,00)	.240 (6,10)
12SWS0928	SWS 928	.065 (1,65)	.500 (12,70)	.070 (1,78)	.250 (6,35)	.140 (3,56)
12SWS0929	SWS 929	.490 (12,44)	.406 (10,31)	.094 (2,38)	.250 (6,35)	.195 (4,95)
12SWS0930	SWS 930	7/32 (5,55)	.468 (11,89)	3/64 (1,19)	.375 (9,53)	.325 (8,26)
12SWS0931	SWS 931	.250 (6,35)	.406 (10,31)	.062 (1,57)	.312 (7,92)	.260 (6,60)
12SWS0932	SWS 932	.132 (3,35)	7/16 (11,10)	.029 (0,74)	.312 (7,93)	.260 (6,60)
12SWS0933	SWS 933	.125 (3,18)	.450 (11,43)	.065 (1,65)	.310 (7,87)	.260 (6,60)
12SWS0934	SWS 934	.250 (6,35)	.750 (19,05)	.050 (1,27)	.312 (7,92)	.260 (6,60)
12SWS0935	SWS 935	.187 (4,75)	.495 (12,57)	.065 (1,65)	.312 (7,92)	.200 (5,08)
12SWS0940	SWS 940	.157 (3,99)	.483 (12,27)	.059 (1,50)	.315 (8,00)	.240 (6,10)
12SWS0950	SWS 950	.157 (3,99)	.472 (11,99)	.181 (4,60)	.315 (8,00)	.205 (5,21)
12SWS0951	SWS 951	.031 (0,79)	.500 (12,70)	.031 (0,79)	.243 (6,17)	.171 (4,34)
12SWS0952	SWS 952	.099 (2,51)	.500 (12,70)	.096 (2,44)	.373 (9,47)	.194 (4,93)

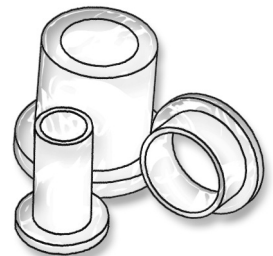
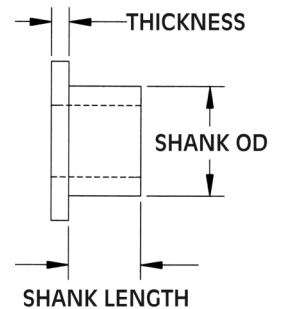
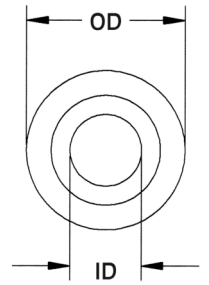

WASHERS, SHOULDER WASHERS & SCREW INSULATORS

SECTION IV

SHOULDER WASHERS

Molded in Natural Nylon 6/6

Nylon Shoulder Washers are suitable for a large variety of insulation and mechanical applications.

► THEY INSULATE ► REDUCE VIBRATION ► ACT AS SPACERS AND GUIDES ► STRONG AND CORROSION RESISTANT ► CAN BE USED AS SEAL IN SOME APPLICATIONS

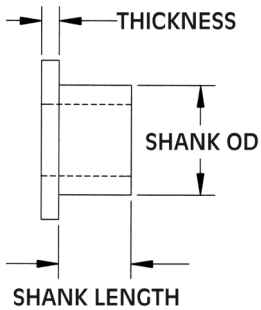
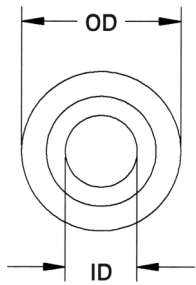

ITEM NUMBER	DESCRIPTION	SHANK LENGTH	OD	THICKNESS	SHANK OD	ID
12SWS0953	SWS 953	.187 (4,75)	.500 (12,70)	.062 (1,57)	.307 (7,80)	.265 (6,73)
12SWS0954	SWS 954	.085 (2,16)	.500 (12,70)	.039 (0,99)	.234 (5,94)	.195 (4,95)
12SWS0955	SWS 955	.080 (2,03)	.500 (12,70)	.118 (3,00)	.213 (5,41)	.145 (3,68)
12SWS0956	SWS 956	.187 (4,75)	1/2 (12,70)	.032 (0,81)	.312 (7,92)	.260 (6,60)
12SWS0957	SWS 957	.060 (1,52)	.281 (7,14)	.285 (7,24)	.233 (5,92)	.194 (4,93)
12SWS0958	SWS 958	.050 (1,27)	.500 (12,70)	.030 (0,76)	.365 (9,27)	.318 (8,08)
12SWS0959	SWS 959	.221 (5,61)	.755 (19,18)	.317 (8,05)	.373 (9,47)	.272 (6,91)
12SWS0966	SWS 966	.031 (7,87)	.563 (14,30)	.031 (0,78)	.438 (11,12)	.375 (9,52)
12SWS0967	SWS 967	.250 (6,35)	.750 (19,05)	.062 (1,57)	.437 (11,1)	.312 (7,92)
12SWS0968	SWS 968	.748 (19,00)	.698 (17,73)	.065 (1,65)	.400 (10,16)	.316 (8,03)
12SWS0969	SWS 969	.335 (8,51)	.551 (14,00)	.059 (1,50)	.413 (10,49)	.335 (8,51)
12SWS0970	SWS 970	.200 (5,08)	.500 (12,70)	.105 (2,67)	.245 (6,22)	.171 (4,34)
12SWS0971	SWS 971	.085 (2,16)	.500 (12,70)	.040 (1,02)	.250 (6,35)	.166 (4,22)
12SWS1000	SWS 1000	.240 (6,10)	.563 (14,30)	.068 (1,73)	.443 (11,25)	.320 (8,13)
12SWS1001	SWS 1001	3/8 (9,53)	.399 (10,13)	1/16 (1,59)	.260 (6,60)	.200 (5,08)
12SWS1002	SWS 1002	3/32 (2,38)	.438 (11,13)	1/16 (1,59)	.267 (6,78)	.203 (5,16)
12SWS1003	SWS 1003	3/16 (4,76)	.745 (18,92)	1/32 (0,79)	.282 (7,16)	.234 (5,94)
12SWS1004	SWS 1004	9/64 (3,58)	.438 (11,13)	1/32 (0,79)	.250 (6,35)	.135 (3,43)
12SWS1005	SWS 1005	5/64 (1,98)	.464 (11,79)	1/64 (0,41)	.312 (7,92)	.255 (6,48)
12SWS1006	SWS 1006	11/64 (4,37)	.425 (10,80)	1/16 (1,59)	.377 (9,58)	.260 (6,60)
12SWS1007	SWS 1007	3/64 (1,19)	.437 (11,10)	3/64 (1,19)	.281 (7,14)	.201 (5,11)
12SWS1008	SWS 1008	3/64 (1,19)	.620 (15,75)	3/64 (1,19)	.312 (7,92)	.205 (5,21)
12SWS1009	SWS 1009	1/16 (1,59)	.740 (18,80)	1/32 (0,79)	.368 (9,53)	.320 (8,13)
12SWS1010	SWS 1010	3/64 (1,19)	.625 (15,88)	7/64 (2,77)	.375 (9,53)	.250 (6,35)
12SWS1011	SWS 1011	1/16 (1,59)	.675 (17,14)	3/32 (2,38)	.480 (12,19)	.257 (6,53)
12SWS1012	SWS 1012	1/8 (3,18)	.697 (17,70)	1/16 (1,59)	.359 (9,12)	.266 (6,76)
12SWS1013	SWS 1013	3/64 (1,19)	.688 (17,48)	1/32 (0,79)	.543 (13,79)	.508 (12,90)
12SWS1014	SWS 1014	1/32 (0,79)	.437 (11,10)	1/32 (0,79)	.310 (7,87)	.253 (6,43)
12SWS1015	SWS 1015	3/64 (1,19)	.500 (12,70)	3/32 (2,38)	.275 (6,99)	.145 (3,68)
12SWS1016	SWS 1016	7/16 (11,11)	.500 (12,70)	1/8 (3,18)	.250 (6,35)	.167 (4,24)
12SWS1017	SWS 1017	1/16 (1,59)	.562 (14,27)	3/32 (2,38)	.375 (9,53)	.260 (6,60)
12SWS1018	SWS 1018	3/16 (4,76)	.625 (15,88)	1/16 (1,59)	.322 (8,18)	.255 (6,48)
12SWS1019	SWS 1019	3/64 (1,19)	.615 (15,62)	1/32 (0,79)	.310 (7,87)	.253 (6,43)
12SWS1020	SWS 1020	1/16 (1,59)	.640 (16,26)	1/16 (1,59)	.380 (9,65)	.195 (4,95)
12SWS1021	SWS 1021	3/64 (1,19)	.630 (16,00)	1/32 (0,79)	.248 (6,30)	.171 (4,34)
12SWS1022	SWS 1022	3/64 (1,19)	.625 (15,88)	1/16 (1,59)	.375 (9,53)	.190 (4,83)
12SWS1023	SWS 1023	3/64 (1,19)	.555 (14,10)	5/64 (1,98)	.300 (7,62)	.260 (6,60)
12SWS1024	SWS 1024	1/2 (12,70)	.620 (15,75)	.031 (0,79)	.370 (9,40)	.316 (8,03)
12SWS1025	SWS 1025	7/16 (11,11)	9/16 (14,28)	1/16 (1,59)	.375 (9,53)	.255 (6,48)
12SWS1026	SWS 1026	1/32 (0,79)	.588 (14,93)	1/32 (0,79)	.253 (6,43)	.198 (5,02)
12SWS1027	SWS 1027	1/2 (12,70)	.500 (12,70)	1/16 (1,59)	.365 (9,27)	.312 (7,92)
12SWS1028	SWS 1028	.249 (6,32)	.500 (12,70)	.062 (1,57)	.250 (6,35)	.189 (4,80)
12SWS1029	SWS 1029	.158 (4,01)	.500 (12,70)	.120 (3,05)	.300 (7,62)	.196 (4,98)
12SWS1030	SWS 1030	3/32 (2,38)	.490 (12,45)	1/16 (1,59)	.281 (7,14)	.200 (5,08)
12SWS1031	SWS 1031	.050 (1,27)	.500 (12,70)	.062 (1,57)	.248 (6,30)	.194 (4,93)
12SWS1032	SWS 1032	1/32 (0,79)	.510 (12,95)	3/32 (2,38)	.250 (6,35)	.156 (3,96)



WASHERS, SHOULDER WASHERS & SCREW INSULATORS

SHOULDER WASHERS

Molded in **Natural Nylon 6/6**

SECTION
IV

Nylon Shoulder Washers are suitable for a large variety of insulation and mechanical applications.

- ▶ THEY INSULATE
- ▶ REDUCE VIBRATION
- ▶ ACT AS SPACERS AND GUIDES
- ▶ STRONG AND CORROSION RESISTANT
- ▶ CAN BE USED AS SEAL IN SOME APPLICATIONS



ITEM NUMBER	DESCRIPTION	SHANK LENGTH		OD		THICKNESS		SHANK OD		ID	
12SWS1033	SWS 1033	5/16	(7,94)	.500	(12,70)	1/16	(1,59)	.312	(7,92)	.200	(5,08)
12SWS1034	SWS 1034	1/32	(0,79)	.500	(12,70)	1/32	(0,79)	.312	(7,92)	.252	(6,40)
12SWS1035	SWS 1035	1/32	(0,79)	.500	(12,70)	1/16	(1,59)	.230	(5,84)	.147	(3,73)
12SWS1036	SWS 1036	1/64	(0,41)	.500	(12,70)	5/64	(1,98)	.250	(6,35)	.165	(4,19)
12SWS1037	SWS 1037	.047	(1,19)	.500	(12,70)	.125	(3,17)	.281	(7,14)	.219	(5,56)
12SWS1038	SWS 1038	1.000	(25,40)	.875	(22,23)	.062	(1,57)	.500	(12,70)	.390	(9,91)
12SWS1039	SWS 1039	.310	(7,87)	.630	(16,0)	.070	(1,78)	.265	(6,73)	.184	(4,67)
12SWS1040	SWS 1040	3/32	(2,38)	.505	(12,83)	1/16	(1,59)	.343	(8,71)	.257	(6,53)
12SWS1041	SWS 1041	.335	(8,51)	.498	(12,65)	.050	(1,27)	.346	(8,79)	.260	(6,60)
12SWS1042	SWS 1042	.027	(0,69)	.500	(12,70)	.031	(0,79)	.248	(6,30)	.199	(5,05)
12SWS1044	SWS 1044	.080	(2,03)	.500	(12,70)	.078	(1,98)	.213	(5,41)	.145	(3,68)
12SWS1045	SWS 1045	3/16	(4,76)	.498	(12,65)	1/4	(6,35)	.310	(7,87)	.195	(4,95)
12SWS1046	SWS 1046	.150	(3,81)	.504	(12,80)	.160	(4,06)	.312	(7,92)	.265	(6,73)
12SWS1047	SWS 1047	1.250	(31,75)	.500	(12,70)	.125	(3,18)	.375	(9,53)	.250	(6,35)
12SWS1048	SWS 1048	7/16	(11,11)	.500	(12,70)	1/16	(1,59)	.375	(9,53)	.250	(6,35)
12SWS1049	SWS 1049	.076	(1,93)	.500	(12,70)	.040	(1,02)	.345	(8,76)	.265	(6,73)
12SWS1050	SWS 1050	5/32	(3,97)	.490	(12,45)	1/16	(1,59)	.250	(6,35)	.190	(4,83)
12SWS1051	SWS 1051	3/64	(1,19)	.441	(11,20)	1/16	(1,59)	.248	(6,30)	.194	(4,92)
12SWS1052	SWS 1052	5/32	(3,97)	.488	(12,39)	1/8	(3,18)	.250	(6,35)	.190	(4,83)
12SWS1053	SWS 1053	.170	(4,32)	.500	(12,70)	.125	(3,17)	.375	(9,52)	.257	(6,53)
12SWS1054	SWS 1054	9/64	(3,58)	.500	(12,70)	1/16	(1,59)	.345	(8,76)	.285	(7,34)
12SWS1056	SWS 1056	.050	(1,27)	.500	(12,70)	.063	(1,60)	.265	(6,73)	.169	(4,29)
12SWS1057	SWS 1057	3/32	(2,38)	.505	(12,83)	1/16	(1,59)	.312	(7,92)	.260	(6,60)
12SWS1058	SWS 1058	1/32	(0,79)	.490	(12,45)	1/32	(0,79)	.310	(7,87)	.193	(4,90)
12SWS1059	SWS 1059	.060	(1,52)	.500	(12,70)	.030	(0,76)	.365	(9,27)	.260	(6,60)
12SWS1060	SWS 1060	5/64	(1,98)	.492	(12,50)	1/32	(0,79)	.318	(8,08)	.265	(6,73)
12SWS1061	SWS 1061	5/32	(3,97)	.488	(12,39)	1/8	(3,18)	.250	(6,35)	.215	(5,46)
12SWS1062	SWS 1062	.075	(1,91)	.500	(12,70)	.063	(1,60)	.265	(6,73)	.169	(4,29)
12SWS1063	SWS 1063	.460	(11,68)	.450	(11,43)	.125	(3,17)	.250	(6,35)	.195	(4,95)
12SWS1064	SWS 1064	.690	(17,53)	.450	(11,43)	.125	(3,17)	.260	(6,60)	.190	(4,83)
12SWS1065	SWS 1065	3/16	(4,76)	.513	(13,03)	1/16	(1,59)	.312	(7,92)	.175	(4,45)
12SWS1066	SWS 1066	.175	(4,44)	.625	(15,87)	.045	(1,14)	.246	(6,25)	.193	(4,90)
12SWS1067	SWS 1067	.316	(8,03)	.502	(12,75)	.054	(1,37)	.254	(6,45)	.194	(4,93)
12SWS1068	SWS 1068	.076	(1,93)	.375	(9,53)	.040	(1,02)	.250	(6,35)	.171	(4,34)
12SWS1069	SWS 1069	.630	(16,00)	.492	(12,50)	.055	(1,40)	.370	(9,40)	.315	(8,00)
12SWS1070	SWS 1070	5/64	(1,98)	.500	(12,70)	1/32	(0,79)	.318	(8,08)	.193	(4,90)
12SWS1071	SWS 1071	.253	(6,43)	.502	(12,75)	.187	(4,75)	.374	(9,50)	.318	(8,08)
12SWS1072	SWS 1072	.065	(1,65)	.615	(15,62)	.062	(1,57)	.346	(8,79)	.252	(6,40)
12SWS1073	SWS 1073	.425	(10,80)	.558	(14,17)	.031	(0,79)	.373	(9,47)	.313	(7,95)
12SWS1074	SWS 1074	.197	(5,00)	.394	(10,01)	.079	(2,01)	.315	(8,00)	.197	(5,00)
12SWS1075	SWS 1075	1/4	(6,35)	.513	(13,03)	1/16	(1,59)	.370	(9,40)	.260	(6,60)
12SWS1077	SWS 1077	.050	(1,27)	.479	(12,17)	.050	(1,27)	.263	(6,68)	.166	(4,22)
12SWS1079	SWS 1079	.122	(3,10)	.500	(12,70)	.167	(4,24)	.270	(6,86)	.222	(5,64)
12SWS1080	SWS 1080	1/64	(0,41)	.500	(12,70)	1/32	(0,79)	.318	(8,08)	.141	(3,58)
12SWS1081	SWS 1081	.375	(9,53)	.500	(12,70)	.093	(2,36)	.411	(10,44)	.380	(9,65)
12SWS1082	SWS 1082	3/64	(1,19)	.500	(12,70)	1/32	(0,79)	.318	(8,08)	.193	(4,90)

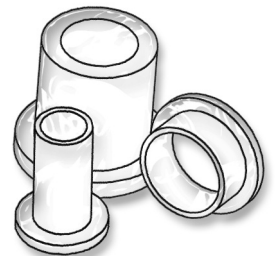
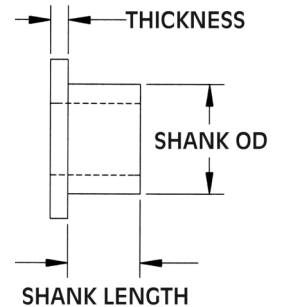
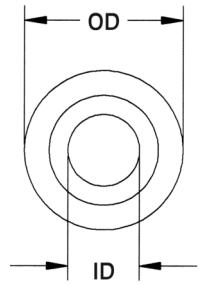

WASHERS, SHOULDER WASHERS & SCREW INSULATORS

SECTION IV

SHOULDER WASHERS

Molded in **Natural Nylon 6/6**

Nylon Shoulder Washers are suitable for a large variety of insulation and mechanical applications.

- ▶ THEY INSULATE
- ▶ REDUCE VIBRATION
- ▶ ACT AS SPACERS AND GUIDES
- ▶ STRONG AND CORROSION RESISTANT
- ▶ CAN BE USED AS SEAL IN SOME APPLICATIONS

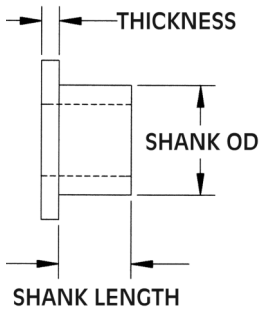
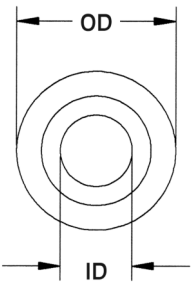

ITEM NUMBER	DESCRIPTION	SHANK LENGTH	OD	THICKNESS	SHANK OD	ID
12SWS1083	SWS 1083	.160 (4,06)	1/2 (12,70)	.062 (1,57)	.360 (9,14)	.260 (6,60)
12SWS1084	SWS 1084	3/64 (1,19)	.500 (12,70)	1/32 (0,79)	.318 (8,08)	.141 (3,58)
12SWS1086	SWS 1086	1/16 (1,59)	.500 (12,70)	1/16 (1,59)	.330 (8,38)	.150 (3,81)
12SWS1087	SWS 1087	.110 (2,79)	.630 (16,00)	.034 (0,86)	.322 (8,18)	.255 (6,48)
12SWS1088	SWS 1088	.109 (2,77)	.500 (12,70)	1/16 (1,59)	.240 (6,10)	.138 (3,51)
12SWS1089	SWS 1089	.050 (1,27)	.505 (12,83)	.050 (1,27)	.410 (10,41)	.370 (9,40)
12SWS1090	SWS 1090	3/64 (1,19)	.518 (13,16)	1/32 (0,79)	.305 (7,75)	.080 (2,03)
12SWS1092	SWS 1092	.075 (1,91)	.500 (12,70)	.175 (4,45)	.300 (7,62)	.195 (4,95)
12SWS1093	SWS 1093	.445 (11,30)	.500 (12,70)	.055 (1,39)	.310 (7,87)	.205 (5,20)
12SWS1094	SWS 1094	.071 (1,80)	.787 (19,99)	.039 (0,99)	.390 (9,91)	.315 (8,00)
12SWS1095	SWS 1095	1/8 (3,18)	.502 (12,75)	1/32 (0,79)	.399 (10,13)	.349 (8,86)
12SWS1096	SWS 1096	.375 (9,53)	.437 (11,10)	.055 (1,40)	.310 (7,87)	.196 (4,98)
12SWS1097	SWS 1097	.071 (1,80)	.787 (19,99)	.039 (0,99)	.390 (9,91)	.350 (8,89)
12SWS1098	SWS 1098	9/64 (3,58)	.515 (13,08)	1/16 (1,59)	.312 (7,93)	.260 (6,60)
12SWS1099	SWS 1099	.085 (2,16)	.880 (22,35)	.058 (1,47)	.312 (7,92)	.260 (6,60)
12SWS1100	SWS 1100	15/16 (23,81)	.540 (13,72)	.065 (1,65)	.370 (9,40)	.260 (6,60)
12SWS1101	SWS 1101	3/32 (2,38)	.500 (12,70)	1/32 (0,79)	.282 (7,16)	.234 (5,94)
12SWS1102	SWS 1102	.050 (1,27)	.750 (19,05)	.100 (2,54)	.280 (7,11)	.200 (5,08)
12SWS1115	SWS 1115	.500 (12,70)	.525 (15,88)	.063 (1,60)	.370 (9,40)	.267 (6,78)
12SWS1145	SWS 1145	.030 (0,76)	.562 (14,28)	.030 (0,76)	.400 (10,16)	.318 (8,08)
12SWS1146	SWS 1146	.375 (9,52)	.700 (17,78)	.062 (1,57)	.395 (10,03)	.318 (8,07)
12SWS1148	SWS 1148	.440 (11,18)	.470 (11,94)	.060 (1,52)	.344 (8,74)	.219 (5,56)
12SWS1149	SWS 1149	.188 (4,78)	.562 (14,27)	.731 (18,57)	.388 (9,86)	.290 (7,37)
12SWS1150	SWS 1150	3/64 (1,19)	.562 (14,28)	3/64 (1,19)	.300 (7,62)	.260 (6,60)
12SWS1151	SWS 1151	.104 (2,64)	.562 (14,28)	.046 (1,17)	.300 (7,62)	.260 (6,60)
12SWS1152	SWS 1152	.500 (12,70)	.525 (13,33)	.063 (1,60)	.370 (9,40)	.265 (6,73)
12SWS1153	SWS 1153	.040 (1,02)	.560 (14,22)	.060 (1,52)	.312 (7,92)	.257 (6,53)
12SWS1154	SWS 1154	.050 (1,27)	.516 (13,11)	.060 (1,52)	.345 (8,76)	.260 (6,60)
12SWS1155	SWS 1155	3/64 (1,19)	.562 (14,28)	.024 (0,61)	.370 (9,40)	.335 (8,51)
12SWS1156	SWS 1156	.050 (1,27)	.515 (13,08)	.039 (0,99)	.338 (8,59)	.260 (6,60)
12SWS1157	SWS 1157	.030 (0,76)	.375 (9,53)	.020 (0,51)	.312 (7,92)	.252 (6,40)
12SWS1158	SWS 1158	.100 (2,54)	.375 (9,53)	.031 (0,79)	.312 (7,92)	.260 (6,60)
12SWS1159	SWS 1159	9/16 (14,29)	.550 (13,97)	1/16 (1,59)	.375 (9,53)	.255 (6,48)
12SWS1160	SWS 1160	1/16 (1,59)	.562 (14,28)	7/64 (2,77)	.365 (9,27)	.215 (5,46)
12SWS1161	SWS 1161	.620 (15,75)	9/16 (14,27)	1/16 (1,57)	.395 (10,03)	.355 (9,02)
12SWS1162	SWS 1162	27/64 (10,72)	.560 (14,22)	1/16 (1,59)	.375 (9,53)	.255 (6,48)
12SWS1163	SWS 1163	15/32 (11,91)	.550 (13,97)	1/16 (1,59)	.380 (9,65)	.247 (6,27)
12SWS1164	SWS 1164	1/32 (0,79)	.562 (14,28)	1/8 (3,18)	.312 (7,93)	.169 (4,29)
12SWS1165	SWS 1165	1/4 (6,35)	.551 (13,99)	1/16 (1,59)	.380 (9,65)	.248 (6,30)
12SWS1166	SWS 1166	.038 (0,97)	.428 (10,87)	.062 (1,57)	.311 (7,90)	.169 (4,29)
12SWS1167	SWS 1167	.128 (3,25)	.591 (15,01)	.197 (5,00)	.394 (10,01)	.157 (3,99)
12SWS1168	SWS 1168	.438 (11,13)	.562 (14,27)	.062 (1,57)	.375 (9,53)	.188 (4,77)
12SWS1169	SWS 1169	.250 (6,35)	.562 (14,27)	.062 (1,57)	.312 (7,92)	.188 (4,77)
12SWS1170	SWS 1170	3/8 (9,53)	.570 (14,48)	1/16 (1,59)	.470 (11,94)	.385 (9,78)
12SWS1171	SWS 1171	.060 (1,52)	.625 (15,87)	.045 (1,14)	.470 (11,94)	.345 (8,76)



WASHERS, SHOULDER WASHERS & SCREW INSULATORS

SHOULDER WASHERS

Molded in **Natural Nylon 6/6**

SECTION
IV

Nylon Shoulder Washers are suitable for a large variety of insulation and mechanical applications.

- ▶ THEY INSULATE
- ▶ REDUCE VIBRATION
- ▶ ACT AS SPACERS AND GUIDES
- ▶ STRONG AND CORROSION RESISTANT
- ▶ CAN BE USED AS SEAL IN SOME APPLICATIONS

ITEM NUMBER	DESCRIPTION	SHANK LENGTH	OD	THICKNESS	SHANK OD	ID
12SWS1172	SWS 1172	.394 (10,01)	.630 (16,00)	.079 (2,01)	.472 (11,99)	.394 (10,01)
12SWS1173	SWS 1173	.349 (8,86)	.839 (21,31)	.261 (6,63)	.475 (12,07)	.388 (9,86)
12SWS1175	SWS 1175	.783 (19,89)	.570 (14,48)	.039 (0,99)	.491 (12,47)	.413 (10,49)
12SWS1176	SWS 1176	.335 (8,51)	.545 (13,84)	.075 (1,91)	.316 (8,03)	.166 (4,22)
12SWS1177	SWS 1177	.110 (2,79)	.571 (14,50)	.074 (6,88)	.526 (13,36)	.441 (11,20)
12SWS1178	SWS 1178	.126 (3,20)	.598 (15,19)	.070 (1,78)	.477 (12,12)	.372 (9,45)
12SWS1180	SWS 1180	3/64 (1,19)	.578 (14,68)	1/16 (1,59)	.185 (4,70)	.140 (3,56)
12SWS1190	SWS 1190	.220 (5,59)	5/8 (15,88)	.061 (1,55)	.355 (9,02)	.266 (6,76)
12SWS1191	SWS 1191	.375 (9,53)	.870 (22,09)	.086 (2,18)	.350 (8,89)	.250 (6,35)
12SWS1193	SWS 1193	.245 (6,22)	.730 (18,54)	.185 (4,70)	.485 (12,32)	.299 (7,59)
12SWS1197	SWS 1197	.342 (8,69)	.625 (15,88)	.125 (3,18)	.485 (12,32)	.390 (9,91)
12SWS1198	SWS 1198	.093 (2,36)	.620 (15,75)	.063 (1,60)	.360 (9,14)	.320 (8,13)
12SWS1199	SWS 1199	.100 (2,54)	.620 (15,75)	.062 (1,57)	.400 (10,16)	.260 (6,60)
12SWS1200	SWS 1200	3/64 (1,19)	.615 (15,62)	3/64 (1,19)	.315 (8,00)	.208 (5,28)
12SWS1201	SWS 1201	1/8 (3,18)	.620 (15,75)	3/8 (9,53)	.360 (9,14)	.320 (8,13)
12SWS1204	SWS 1204	.500 (12,70)	.600 (15,24)	.025 (0,64)	.485 (12,32)	.324 (8,23)
12SWS1205	SWS 1205	1/32 (0,79)	.622 (15,80)	3/64 (1,19)	.434 (11,02)	.383 (9,73)
12SWS1207	SWS 1207	.163 (4,14)	.625 (15,88)	.040 (1,02)	.281 (7,14)	.219 (5,56)
12SWS1208	SWS 1208	.100 (2,54)	.620 (15,75)	.060 (1,52)	.502 (12,75)	.316 (8,03)
12SWS1209	SWS 1209	.045 (1,14)	.750 (19,05)	.065 (1,65)	.520 (13,20)	.450 (11,43)
12SWS1210	SWS 1210	1/32 (0,79)	.625 (15,88)	1/16 (1,59)	.495 (12,57)	.378 (9,60)
12SWS1211	SWS 1211	.139 (3,53)	.625 (15,88)	.066 (1,68)	.405 (10,29)	.320 (8,13)
12SWS1212	SWS 1212	.025 (0,64)	.625 (15,88)	.062 (1,57)	.375 (9,53)	.200 (5,08)
12SWS1213	SWS 1213	.031 (0,79)	.630 (16,00)	.031 (0,79)	.437 (11,10)	.380 (9,65)
12SWS1214	SWS 1214	.150 (3,81)	.630 (16,00)	.050 (1,27)	.375 (9,53)	.280 (7,11)
12SWS1215	SWS 1215	.062 (1,57)	.625 (15,88)	1/32 (0,79)	.310 (7,87)	.195 (4,95)
12SWS1216	SWS 1216	.433 (11,00)	.630 (16,00)	.079 (2,01)	.433 (11,00)	.315 (8,00)
12SWS1217	SWS 1217	.030 (0,76)	.625 (15,88)	.030 (0,76)	.447 (12,12)	.378 (9,60)
12SWS1218	SWS 1218	.138 (3,51)	.561 (14,25)	.059 (1,59)	.443 (11,25)	.323 (8,20)
12SWS1219	SWS 1219	3/64 (1,19)	.625 (15,88)	1/16 (1,59)	.310 (7,87)	.172 (4,37)
12SWS1220	SWS 1220	3/4 (19,05)	.620 (15,75)	1/8 (3,18)	.400 (10,60)	.260 (6,60)
12SWS1221	SWS 1221	1/8 (3,18)	.630 (16,00)	1/16 (1,59)	.327 (8,31)	.260 (6,60)
12SWS1222	SWS 1222	1/32 (0,79)	.625 (15,88)	1/32 (0,79)	.448 (11,37)	.378 (9,60)
12SWS1223	SWS 1223	.073 (1,85)	.625 (15,87)	.047 (1,19)	.328 (8,33)	.266 (6,76)
12SWS1224	SWS 1224	.070 (1,78)	.560 (14,22)	.060 (1,52)	.450 (11,43)	.175 (4,44)
12SWS1225	SWS 1225	.027 (0,69)	.625 (15,88)	.062 (1,57)	.248 (6,30)	.120 (3,05)
12SWS1226	SWS 1226	.250 (6,35)	1.000 (25,40)	.050 (1,27)	.320 (8,13)	.260 (6,60)
12SWS1227	SWS 1227	.210 (5,33)	.625 (15,88)	.058 (1,47)	.379 (9,63)	.263 (6,68)
12SWS1228	SWS 1228	.025 (0,64)	.625 (15,88)	.060 (1,52)	.219 (5,56)	.140 (3,56)
12SWS1229	SWS 1229	.194 (4,92)	.549 (13,94)	.082 (2,08)	.449 (11,40)	.176 (4,47)
12SWS1230	SWS 1230	3/64 (1,19)	.550 (13,97)	5/64 (1,98)	.305 (7,75)	.260 (6,60)
12SWS1232	SWS 1232	1/2 (12,70)	.620 (15,75)	1/16 (1,59)	.370 (9,40)	.316 (8,03)
12SWS1233	SWS 1233	.090 (2,29)	.625 (15,88)	.062 (1,57)	.311 (7,90)	.253 (6,43)
12SWS1234	SWS 1234	.315 (8,00)	.394 (10,01)	.063 (1,60)	.252 (6,40)	.197 (5,00)
12SWS1235	SWS 1235	.150 (3,81)	.620 (15,75)	.060 (1,52)	.502 (12,75)	.316 (8,03)

**New
SIZES**

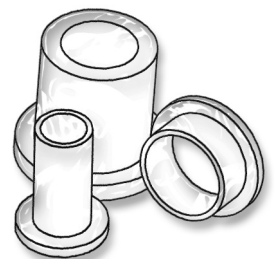
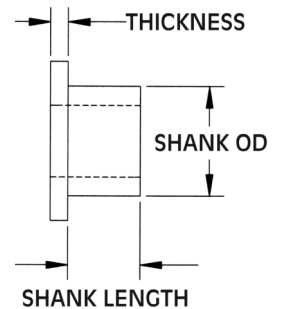
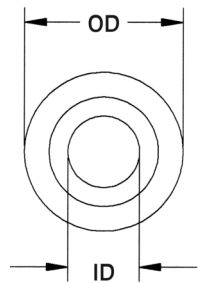

WASHERS, SHOULDER WASHERS & SCREW INSULATORS

SECTION IV

SHOULDER WASHERS

Molded in **Natural Nylon 6/6**

Nylon Shoulder Washers are suitable for a large variety of insulation and mechanical applications.

► THEY INSULATE ► REDUCE VIBRATION ► ACT AS SPACERS AND GUIDES ► STRONG AND CORROSION RESISTANT ► CAN BE USED AS SEAL IN SOME APPLICATIONS

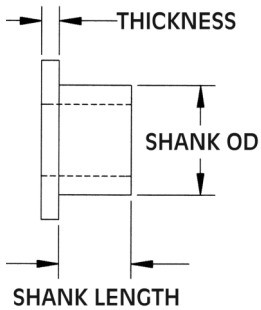
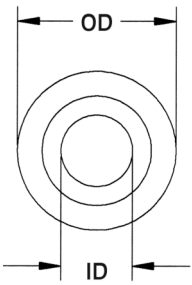

ITEM NUMBER	DESCRIPTION	SHANK LENGTH		OD	THICKNESS		SHANK OD		ID
12SWS1238	SWS 1238	.250	(6,35)	.750 (19,05)	.120	(3,05)	.255	(6,48)	.220 (5,59)
12SWS1239	SWS 1239	.188	(4,78)	.625 (15,88)	.032	(0,81)	.260	(6,60)	.200 (5,08)
12SWS1240	SWS 1240	3/16	(4,76)	.630 (16,00)	1/16	(1,59)	.375	(9,53)	.254 (6,45)
12SWS1241	SWS 1241	.175	(4,45)	.650 (16,51)	.125	(3,18)	.490	(12,45)	.385 (9,78)
12SWS1242	SWS 1242	.563	(14,30)	.625 (15,88)	.125	(3,18)	.485	(12,32)	.390 (9,91)
12SWS1243	SWS 1243	.748	(19,00)	.630 (16,00)	.055	(1,40)	.500	(12,70)	.437 (11,10)
12SWS1244	SWS 1244	.090	(2,29)	.635 (16,13)	.042	(1,07)	.380	(9,65)	.216 (5,49)
12SWS1245	SWS 1245	.500	(12,70)	1.000 (25,40)	.130	(3,30)	.493	(12,52)	.280 (7,11)
12SWS1247	SWS 1247	.375	(9,53)	.625 (15,88)	.063	(1,60)	.500	(12,70)	.380 (9,65)
12SWS2101	SWS 2101	.062	(1,57)	.562 (14,27)	.062	(1,57)	.365	(9,27)	.215 (5,46)
12SWS2102	SWS 2102	.220	(5,59)	.620 (15,75)	.057	(1,45)	.366	(9,30)	.310 (7,87)
12SWS2104	SWS 2104	.225	(5,71)	1/2 (12,70)	.035	(0,89)	.370	(9,40)	.310 (7,87)
12SWS2105	SWS 2105	.125	(3,17)	.750 (19,05)	.062	(1,57)	.375	(9,52)	.312 (7,92)
12SWS2106	SWS 2106	.187	(4,74)	.691 (17,55)	.067	(1,70)	.363	(9,22)	.256 (6,50)
12SWS2495	SWS 2495	.142	(3,60)	.375 (9,52)	.063	(1,60)	.232	(5,89)	.139 (3,53)
12SWS2496	SWS 2496	.150	(3,81)	.343 (8,71)	.263	(6,68)	.232	(5,89)	.130 (3,30)
12SWS2497	SWS 2497	.150	(3,81)	.343 (8,71)	.340	(8,64)	.232	(5,89)	.130 (3,30)
12SWS2498	SWS 2498	.513	(13,03)	.687 (17,44)	.263	(6,68)	.412	(10,46)	.325 (8,26)
12SWS2499	SWS 2499	3/8	(9,53)	.513 (13,03)	1/16	(1,59)	.312	(7,93)	.191 (4,85)
12SWS2500	SWS 2500	1/32	(7,94)	.510 (12,95)	3/32	(2,38)	.250	(6,35)	.156 (3,96)
12SWS2501	SWS 2501	3/8	(9,53)	.513 (13,03)	1/16	(1,59)	.312	(7,93)	.261 (6,63)
12SWS2502	SWS 2502	1/8	(3,18)	.467 (11,86)	3/64	(1,19)	.312	(7,93)	.255 (6,48)
12SWS2503	SWS 2503	1/32	(0,79)	.625 (15,88)	1/16	(1,59)	.375	(9,53)	.295 (7,49)
12SWS2504	SWS 2504	1/8	(3,18)	.687 (17,45)	1/8	(3,18)	.437	(11,10)	.328 (8,33)
12SWS2505	SWS 2505	1/32	(0,79)	.500 (12,70)	1/16	(1,59)	.312	(7,93)	.252 (6,40)
12SWS2506	SWS 2506	5/16	(7,94)	.625 (15,88)	1/16	(1,59)	.500	(12,70)	.380 (9,65)
12SWS2507	SWS 2507	1/8	(3,18)	.600 (15,24)	1/8	(3,18)	.370	(7,93)	.250 (6,35)
12SWS2508	SWS 2508	3/16	(4,76)	.674 (17,12)	3/32	(2,38)	.500	(12,70)	.290 (7,36)
12SWS2509	SWS 2509	1-7/64	(28,17)	.635 (16,13)	9/64	(3,58)	.425	(10,80)	.201 (5,11)
12SWS2510	SWS 2510	3/8	(9,53)	.687 (17,45)	3/8	(9,53)	.359	(9,12)	.263 (6,68)
12SWS2511	SWS 2511	5/16	(7,94)	.625 (15,88)	1/16	(1,59)	.500	(12,70)	.395 (10,03)
12SWS2512	SWS 2512	.334	(8,48)	.687 (17,45)	.046	(1,17)	.348	(8,84)	.263 (6,68)
12SWS2513	SWS 2513	1/8	(3,18)	.703 (17,86)	1/16	(1,59)	.437	(11,10)	.335 (8,51)
12SWS2515	SWS 2515	.420	(10,67)	.710 (18,03)	.075	(1,90)	.470	(11,94)	.420 (10,67)
12SWS2516	SWS 2516	.280	(7,11)	.701 (17,80)	.062	(1,57)	.305	(7,75)	.258 (6,55)
12SWS2517	SWS 2517	.110	(2,79)	.710 (18,03)	.190	(4,83)	.338	(8,59)	.255 (6,48)
12SWS2518	SWS 2518	.146	(3,71)	.692 (17,58)	.051	(1,30)	.417	(10,59)	.249 (6,32)
12SWS2519	SWS 2519	.145	(3,68)	.736 (18,69)	.125	(3,18)	.371	(9,42)	.168 (4,27)
12SWS2520	SWS 2520	5/32	(3,97)	.725 (18,41)	5/32	(3,97)	.445	(11,30)	.375 (9,53)
12SWS2521	SWS 2521	5/32	(3,97)	.720 (18,29)	1/16	(1,59)	.485	(12,32)	.270 (6,86)
12SWS2522	SWS 2522	.187	(4,75)	.700 (17,78)	.225	(5,72)	.375	(9,53)	.268 (6,81)
12SWS2523	SWS 2523	.062	(1,59)	.750 (19,05)	.188	(4,78)	.500	(12,70)	.250 (6,35)
12SWS2524	SWS 2524	.150	(3,81)	.730 (18,54)	.125	(3,18)	.500	(12,70)	.315 (8,00)
12SWS2525	SWS 2525	11/32	(3,43)	.730 (18,54)	1/4	(6,35)	.372	(9,44)	.257 (6,52)
12SWS2526	SWS 2526	.500	(12,70)	.688 (17,48)	.062	(1,58)	.562	(14,27)	.437 (11,10)
12SWS2527	SWS 2527	11/16	(17,46)	.750 (19,05)	1/16	(1,59)	.438	(11,13)	.313 (7,95)



WASHERS, SHOULDER WASHERS & SCREW INSULATORS

SHOULDER WASHERS

Molded in **Natural Nylon 6/6**

SECTION
IV

Nylon Shoulder Washers are suitable for a large variety of insulation and mechanical applications.

- ▶ THEY INSULATE
- ▶ REDUCE VIBRATION
- ▶ ACT AS SPACERS AND GUIDES
- ▶ STRONG AND CORROSION RESISTANT
- ▶ CAN BE USED AS SEAL IN SOME APPLICATIONS

ITEM NUMBER	DESCRIPTION	SHANK LENGTH		OD		THICKNESS		SHANK OD		ID	
12SWS2528	SWS 2528	3/16	(4,76)	.743	(18,87)	1/16	(1,59)	.443	(11,25)	.375	(9,53)
12SWS2529	SWS 2529	19/32	(15,08)	.750	(19,05)	.060	(1,52)	.528	(13,41)	.385	(9,78)
12SWS2530	SWS 2530	.200	(5,08)	.740	(18,80)	.050	(1,27)	.563	(14,30)	.380	(9,65)
12SWS2531	SWS 2531	5/16	(7,94)	.743	(18,87)	5/64	(1,98)	.502	(12,75)	.383	(9,72)
12SWS2532	SWS 2532	.155	(3,94)	.745	(18,92)	.100	(2,54)	.545	(13,84)	.391	(9,93)
12SWS2533	SWS 2533	.375	(9,52)	3/4	(19,05)	.375	(9,52)	.594	(15,09)	.380	(9,65)
12SWS2534	SWS 2534	.187	(4,75)	.745	(18,92)	.031	(0,79)	.282	(7,16)	.234	(5,94)
12SWS2535	SWS 2535	.118	(3,00)	.750	(19,05)	.032	(0,81)	.688	(17,48)	.569	(14,45)
12SWS2536	SWS 2536	.031	(0,79)	.750	(19,05)	.062	(1,58)	.500	(12,70)	.375	(9,53)
12SWS2538	SWS 2538	1/8	(3,18)	3/4	(19,05)	1/16	(1,59)	.469	(11,91)	.344	(8,74)
12SWS2539	SWS 2539	11/32	(8,73)	.740	(18,80)	3/32	(2,38)	.375	(9,53)	.266	(6,76)
12SWS2540	SWS 2540	1/8	(3,18)	.740	(18,80)	3/32	(2,38)	.371	(9,42)	.266	(6,76)
12SWS2541	SWS 2541	5/64	(1,98)	.750	(19,05)	3/32	(2,38)	.380	(9,65)	.266	(6,76)
12SWS2542	SWS 2542	3/64	(1,19)	.750	(19,05)	3/16	(4,76)	.500	(12,70)	.430	(10,92)
12SWS2543	SWS 2543	.779	(19,79)	.750	(19,05)	.095	(2,41)	.490	(12,45)	.189	(4,80)
12SWS2544	SWS 2544	1.00	(25,40)	.75	(19,05)	.095	(2,41)	.375	(9,53)	.265	(6,73)
12SWS2545	SWS 2545	.100	(2,54)	3/4	(19,05)	.086	(2,18)	.500	(12,70)	.250	(6,35)
12SWS2546	SWS 2546	.125	(3,18)	.750	(19,05)	.187	(4,75)	.500	(12,70)	.344	(8,74)
12SWS2547	SWS 2547	.250	(6,35)	.750	(19,05)	.062	(1,57)	.617	(15,67)	.509	(12,93)
12SWS2548	SWS 2548	.425	(10,80)	.750	(19,05)	1/16"	(1,59)	.590	(14,99)	.375	(9,53)
12SWS2549	SWS 2549	.140	(3,56)	.750	(19,05)	.031	(0,79)	.708	(17,98)	.630	(16,00)
12SWS2550	SWS 2550	1/16	(1,59)	.734	(18,64)	1/8"	(3,18)	.488	(12,40)	.250	(6,35)
12SWS2551	SWS 2551	3/64	(1,19)	.753	(19,12)	5/64	(1,98)	.409	(10,38)	.258	(6,55)
12SWS2552	SWS 2552	7/64	(2,77)	.743	(18,87)	3/32	(2,38)	.500	(12,70)	.375	(9,53)
12SWS2553	SWS 2553	5/16	(7,94)	.750	(19,05)	5/64	(1,98)	.500	(12,70)	.370	(9,39)
12SWS2554	SWS 2554	3/64	(1,19)	.735	(18,67)	3/16	(4,76)	.490	(12,45)	.435	(11,05)
12SWS2555	SWS 2555	.098	(2,49)	.747	(18,87)	.079	(2,01)	.482	(12,24)	.358	(9,09)
12SWS2556	SWS 2556	3/16	(4,76)	.750	(19,05)	1/16	(1,59)	.500	(12,70)	.375	(9,53)
12SWS2557	SWS 2557	23/64	(10,00)	.748	(18,99)	1/8	(3,18)	.507	(12,87)	.384	(9,75)
12SWS2558	SWS 2558	1/8	(3,18)	.750	(19,05)	1/16	(1,59)	.500	(12,70)	.375	(9,53)
12SWS2559	SWS 2559	.020	(0,51)	.750	(19,05)	.074	(1,88)	.495	(12,57)	.385	(9,78)
12SWS2560	SWS 2560	3/64	(1,19)	.750	(19,05)	1/32	(0,79)	.371	(9,42)	.253	(6,43)
12SWS2561	SWS 2561	27/64	(10,72)	.750	(19,05)	11/64	(4,37)	.434	(11,02)	.312	(7,93)
12SWS2562	SWS 2562	1/4	(3,38)	.755	(19,17)	5/64	(1,98)	.505	(12,83)	.378	(9,60)
12SWS2563	SWS 2563	3/32	(1,19)	.750	(19,05)	1/8	(3,18)	.375	(9,53)	.265	(6,73)
12SWS2564	SWS 2564	1/4	(6,35)	.750	(19,05)	1/16	(1,59)	.250	(6,35)	.150	(3,81)
12SWS2565	SWS 2565	.250	(6,35)	.750	(19,05)	.190	(4,83)	.500	(12,70)	.310	(7,87)
12SWS2566	SWS 2566	15/32	(11,90)	.740	(18,80)	5/32	(3,97)	.375	(9,53)	.250	(6,35)
12SWS2567	SWS 2567	.174	(4,42)	.750	(19,05)	.066	(1,68)	.625	(15,88)	.470	(11,94)
12SWS2568	SWS 2568	3/64	(1,19)	.750	(19,05)	1/32	(0,79)	.341	(8,66)	.253	(6,43)
12SWS2569	SWS 2569	.420	(10,67)	.550	(13,97)	.172	(4,37)	.436	(11,07)	.307	(7,80)
12SWS2570	SWS 2570	11/16	(17,46)	.740	(18,80)	9/64	(3,58)	.385	(9,78)	.260	(6,60)
12SWS2571	SWS 2571	.320	(8,13)	.750	(19,05)	.030	(0,76)	.580	(14,73)	.517	(13,13)
12SWS2572	SWS 2572	1/2	(12,70)	.750	(19,05)	1/16	(1,59)	.375	(9,53)	.125	(3,18)
12SWS2573	SWS 2573	.125	(3,18)	.750	(19,05)	.093	(2,36)	.375	(9,53)	.172	(4,37)
12SWS2574	SWS 2574	.360	(9,14)	.750	(19,05)	.062	(1,57)	.506	(12,85)	.380	(9,65)

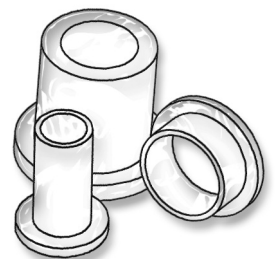
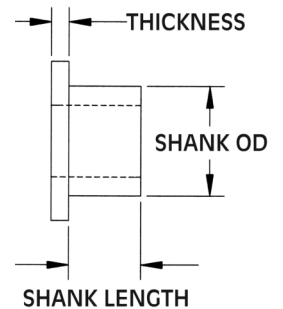
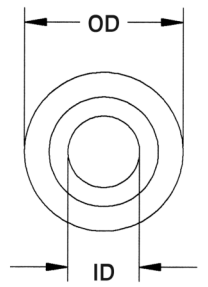

WASHERS, SHOULDER WASHERS & SCREW INSULATORS

SECTION IV

SHOULDER WASHERS

Molded in **Natural Nylon 6/6**

Nylon Shoulder Washers are suitable for a large variety of insulation and mechanical applications.

► THEY INSULATE ► REDUCE VIBRATION ► ACT AS SPACERS AND GUIDES ► STRONG AND CORROSION RESISTANT ► CAN BE USED AS SEAL IN SOME APPLICATIONS

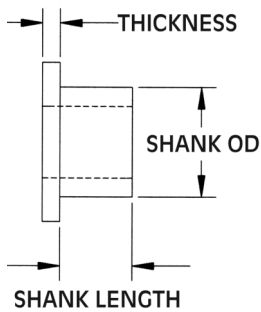
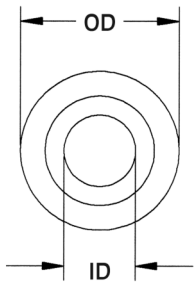

ITEM NUMBER	DESCRIPTION	SHANK LENGTH	OD	THICKNESS	SHANK OD	ID
12SWS2575	SWS 2575	5/64 (20,24)	.750 (19,06)	3/32 (2,38)	.320 (8,12)	.190 (4,83)
12SWS2576	SWS 2576	1/32 (0,76)	.750 (19,05)	1/32 (0,79)	.500 (12,70)	.219 (5,56)
12SWS2577	SWS 2577	.250 (6,35)	.750 (19,05)	.065 (1,65)	.320 (8,13)	.170 (4,32)
12SWS2578	SWS 2578	3/16 (4,76)	.750 (19,06)	1/16 (1,59)	.628 (15,95)	.510 (12,95)
12SWS2579	SWS 2579	.180 (4,57)	.750 (19,05)	.240 (6,10)	.500 (12,70)	.370 (9,40)
12SWS2580	SWS 2580	5/16 (7,94)	.745 (18,92)	1/32 (0,79)	.563 (14,30)	.500 (12,70)
12SWS2581	SWS 2581	1/4 (6,35)	.750 (19,05)	5/64 (1,98)	.505 (12,83)	.315 (8,00)
12SWS2582	SWS 2582	.250 (6,35)	.625 (15,88)	.062 (1,59)	1/2 (12,70)	.312 (7,94)
12SWS2583	SWS 2583	.085 (2,16)	.510 (12,95)	.060 (1,52)	.315 (8,00)	.175 (4,45)
12SWS2584	SWS 2584	.050 (1,27)	.735 (18,67)	.050 (1,27)	.710 (18,03)	.640 (16,26)
12SWS2585	SWS 2585	1/4 (6,35)	.740 (18,80)	1/2 (12,70)	.605 (15,37)	.380 (9,65)
12SWS2586	SWS 2586	1/4 (6,35)	.750 (19,05)	1/8 (3,18)	.500 (12,70)	.281 (7,14)
12SWS2587	SWS 2587	7/16 (11,11)	3/4 (19,05)	1/16 (1,59)	5/8 (15,88)	1/2 (12,70)
12SWS2588	SWS 2588	.196 (4,98)	.752 (19,10)	.058 (1,47)	.476 (12,09)	.378 (9,60)
12SWS2589	SWS 2589	.057 (1,45)	.877 (22,28)	.135 (3,43)	.565 (14,35)	.504 (12,80)
12SWS2590	SWS 2590	.018 (0,46)	.745 (18,92)	.085 (2,16)	.305 (7,75)	.200 (5,08)
12SWS2591	SWS 2591	.050 (1,27)	.875 (22,23)	.031 (0,79)	.580 (14,73)	.520 (13,21)
12SWS2592	SWS 2592	.118 (2,99)	1.008 (25,60)	.079 (2,00)	.583 (14,80)	.476 (12,09)
12SWS2593	SWS 2593	.080 (2,03)	.701 (17,80)	.058 (1,47)	.426 (10,82)	.152 (3,86)
12SWS3001	SWS 3001	1/8 (3,18)	.693 (17,60)	1/16 (1,59)	.437 (11,10)	.328 (8,33)
12SWS3002	SWS 3002	3/64 (1,19)	.750 (19,05)	3/64 (1,19)	.375 (9,53)	.323 (8,20)
12SWS3003	SWS 3003	7/32 (5,55)	.750 (19,05)	3/32 (2,38)	.380 (9,65)	.266 (6,76)
12SWS3004	SWS 3004	1/16 (1,59)	.750 (19,05)	3/32 (2,38)	.359 (9,12)	.152 (3,86)
12SWS3005	SWS 3005	5/32 (3,97)	.750 (19,05)	1/32 (0,79)	.498 (12,64)	.378 (9,60)
12SWS3006	SWS 3006	1/32 (0,79)	.750 (19,05)	1/8 (3,18)	.500 (12,70)	.375 (9,53)
12SWS3007	SWS 3007	1/16 (1,59)	.750 (19,05)	1/8 (3,18)	.500 (12,70)	.375 (9,53)
12SWS3008	SWS 3008	1/16 (1,59)	.745 (18,92)	1/32 (0,79)	.370 (9,40)	.320 (8,13)
12SWS3009	SWS 3009	3/64 (1,19)	.760 (19,30)	5/64 (1,98)	.410 (10,41)	.258 (6,55)
12SWS3010	SWS 3010	.027 (0,68)	.750 (19,05)	.031 (0,79)	.310 (7,87)	.257 (6,53)
12SWS3011	SWS 3011	.196 (4,98)	.763 (19,38)	.026 (0,66)	.562 (14,27)	.394 (10,01)
12SWS3012	SWS 3012	.395 (10,03)	.740 (18,80)	.065 (1,65)	.430 (10,92)	.322 (8,18)
12SWS3013	SWS 3013	.106 (2,69)	.545 (13,84)	.148 (3,76)	.416 (10,57)	.255 (6,48)
12SWS3014	SWS 3014	.060 (1,52)	.680 (17,27)	.060 (1,52)	.495 (12,57)	.390 (9,91)
12SWS3015	SWS 3015	1.005 (25,53)	.752 (19,10)	.060 (1,52)	.505 (12,83)	.320 (8,13)
12SWS3016	SWS 3016	.050 (1,27)	.745 (18,82)	1/16 (1,59)	.556 (14,12)	.515 (13,08)
12SWS3017	SWS 3017	5/32 (3,97)	.755 (19,18)	1/2 (12,70)	.510 (12,95)	.385 (9,78)
12SWS3018	SWS 3018	.060 (1,52)	1.060 (26,96)	.060 (1,52)	.515 (13,08)	.395 (10,03)
12SWS3019	SWS 3019	.155 (3,93)	.750 (19,05)	.075 (1,90)	.527 (13,38)	.408 (10,36)
12SWS3020	SWS 3020	.305 (7,75)	.740 (18,80)	.130 (3,30)	.495 (12,57)	.219 (5,56)
12SWS3021	SWS 3021	.440 (11,18)	.745 (18,92)	1/16 (1,59)	.495 (12,57)	.390 (9,91)
12SWS3022	SWS 3022	.188 (4,78)	.750 (19,05)	.092 (2,34)	.627 (15,93)	.506 (12,85)
12SWS3023	SWS 3023	.216 (5,49)	.765 (19,43)	.126 (3,20)	.481 (12,22)	.250 (6,35)
12SWS3024	SWS 3024	.240 (6,10)	.750 (19,05)	.070 (1,78)	.490 (12,45)	.375 (9,52)
12SWS3025	SWS 3025	5/16 (7,92)	3/4 (19,05)	.062 (1,59)	.625 (15,88)	.505 (12,83)
12SWS3026	SWS 3026	.125 (3,18)	1.000 (25,4)	.125 (3,18)	.625 (15,88)	.515 (13,08)



WASHERS, SHOULDER WASHERS & SCREW INSULATORS

SECTION
IV

SHOULDER WASHERS

Molded in **Natural Nylon 6/6**

Nylon Shoulder Washers are suitable for a large variety of insulation and mechanical applications.

► THEY INSULATE ► REDUCE VIBRATION ► ACT AS SPACERS AND GUIDES ► STRONG AND CORROSION RESISTANT ► CAN BE USED AS SEAL IN SOME APPLICATIONS

ITEM NUMBER	DESCRIPTION	SHANK LENGTH		OD		THICKNESS		SHANK OD		ID	
12SWS3027	SWS 3027	.709	(18,01)	1.102	(27,99)	.118	(3,00)	.709	(18,01)	.551	(14,00)
12SWS3028	SWS 3028	.250	(6,35)	1.188	(30,17)	.031	(0,79)	.625	(15,88)	.563	(14,30)
12SWS3029	SWS 3029	.058	(1,47)	.788	(20,02)	.058	(1,47)	.710	(18,03)	.639	(16,23)
12SWS3030	SWS 3030	.252	(6,40)	.780	(19,81)	.079	(2,01)	.392	(9,96)	.250	(6,35)
12SWS3031	SWS 3031	.110	(2,79)	.810	(20,57)	.130	(3,30)	.498	(12,65)	.388	(9,86)
12SWS3032	SWS 3032	.108	(2,74)	.805	(20,45)	.132	(3,35)	.502	(12,75)	.324	(8,23)
12SWS3033	SWS 3033	.582	(14,78)	.880	(22,35)	.153	(3,89)	.495	(12,57)	.322	(8,18)
12SWS3034	SWS 3034	.050	(1,27)	.750	(19,05)	.031	(0,78)	.498	(12,64)	.378	(9,60)
12SWS3035	SWS 3035	.440	(11,17)	.625	(15,88)	.060	(1,52)	.500	(12,70)	.375	(9,53)
12SWS3036	SWS 3036	.031	(0,79)	1.000	(25,40)	.062	(1,57)	.500	(12,70)	.375	(9,53)
12SWS3100	SWS 3100	.325	(8,26)	.825	(20,96)	.060	(1,52)	.435	(11,05)	.310	(7,87)
12SWS3101	SWS 3101	1/32	(0,79)	.750	(19,05)	1/16	(1,59)	.375	(9,53)	.260	(6,60)
12SWS3102	SWS 3102	1/2	(12,70)	.825	(20,96)	1/16	(1,59)	.620	(15,75)	.520	(13,21)
12SWS3103	SWS 3103	1/2	(12,70)	.872	(22,14)	1/8	(3,18)	.617	(15,67)	.335	(8,51)
12SWS3104	SWS 3104	.125	(3,18)	.750	(19,05)	.075	(1,91)	.437	(11,10)	.265	(6,73)
12SWS3105	SWS 3105	.190	(4,83)	.825	(20,96)	.060	(1,52)	.435	(11,05)	.310	(7,87)
12SWS3106	SWS 3106	.204	(5,18)	.875	(22,23)	.062	(1,57)	.626	(15,90)	.379	(9,63)
12SWS3107	SWS 3107	.180	(4,57)	.740	(18,80)	.090	(2,29)	.435	(11,05)	.318	(8,08)
12SWS3108	SWS 3108	.354	(8,99)	.740	(18,80)	.090	(2,29)	.435	(11,05)	.312	(7,92)
12SWS3109	SWS 3109	.110	(2,79)	.750	(19,05)	.075	(1,90)	.437	(11,09)	.265	(6,73)
12SWS3149	SWS 3149	.455	(11,56)	.865	(21,97)	.045	(1,14)	.600	(15,24)	.510	(12,95)
12SWS3150	SWS 3150	1	(25,40)	.875	(22,23)	1/16	(1,59)	.500	(12,70)	.375	(9,53)
12SWS3151	SWS 3151	3/8	(9,53)	7/8	(22,22)	1/8	(3,17)	.633	(16,08)	.510	(12,95)
12SWS3152	SWS 3152	.375	(9,52)	.875	(22,22)	.125	(3,17)	.630	(16,00)	.320	(8,12)
12SWS3154	SWS 3154	.375	(9,53)	.875	(22,23)	.125	(3,18)	.620	(15,75)	.380	(9,65)
12SWS3155	SWS 3155	3/8	(9,53)	.875	(22,23)	1/8	(3,18)	.630	(16,00)	.440	(11,18)
12SWS3156	SWS 3156	.689	(17,50)	.874	(22,20)	.063	(1,60)	.634	(16,10)	.507	(12,88)
12SWS3157	SWS 3157	.500	(12,70)	.750	(19,05)	.094	(2,38)	.625	(15,87)	.380	(9,65)
12SWS3160	SWS 3160	1/2	(12,70)	.875	(22,23)	1/16	(1,59)	.750	(19,05)	.635	(16,13)
12SWS3161	SWS 3161	.335	(8,51)	.875	(22,23)	.040	(1,02)	.688	(17,48)	.569	(14,45)
12SWS3162	SWS 3162	.125	(3,17)	1.000	(25,40)	.032	(0,81)	.687	(17,44)	.500	(12,70)
12SWS3163	SWS 3163	.511	(12,97)	.940	(23,87)	.102	(2,59)	.696	(17,67)	.476	(12,09)
12SWS3165	SWS 3165	3/8	(9,53)	.875	(22,23)	1/8	(3,18)	.620	(15,75)	.250	(6,35)
12SWS3166	SWS 3166	.380	(9,65)	.882	(22,40)	.125	(3,17)	.619	(15,72)	.270	(6,85)
12SWS3167	SWS 3167	.250	(6,35)	.750	(19,05)	.062	(1,57)	.617	(15,67)	.520	(13,20)
12SWS3168	SWS 3168	.275	(6,98)	.954	(24,23)	.106	(2,69)	.695	(17,95)	.488	(12,39)
12SWS3200	SWS 3200	3/16	(4,76)	.995	(25,27)	1/8	(3,18)	.792	(20,12)	.695	(17,65)
12SWS3205	SWS 3205	5/8	(15,88)	.995	(25,27)	1/8	(3,18)	.787	(19,99)	.695	(17,65)
12SWS3206	SWS 3206	.200	(5,08)	1.000	(25,40)	.050	(1,27)	.780	(19,81)	.640	(16,26)
12SWS3210	SWS 3210	1	(25,40)	.995	(25,27)	1/8	(3,18)	.787	(19,99)	.695	(17,65)
12SWS3500	SWS 3500	3/16	(4,76)	.750	(19,05)	1/16	(1,59)	.498	(12,64)	.378	(9,60)
12SWS3501	SWS 3501	7/64	(2,77)	.750	(19,05)	3/32	(2,38)	.577	(14,66)	.390	(9,91)
12SWS3502	SWS 3502	27/64	(10,72)	.790	(20,07)	3/64	(1,19)	.625	(15,88)	.550	(13,97)
12SWS3503	SWS 3503	13/16	(20,64)	.625	(15,88)	1/8	(3,18)	.375	(9,53)	.255	(6,47)
12SWS3504	SWS 3504	13/16	(20,64)	.625	(15,88)	1/8	(3,18)	.375	(9,53)	.260	(6,60)

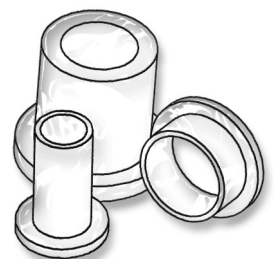
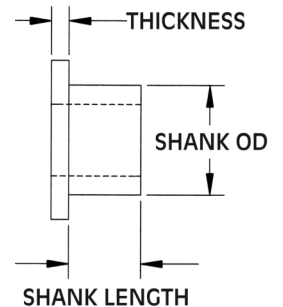
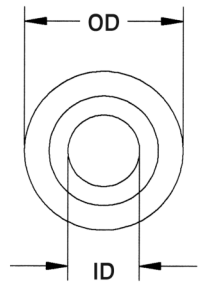

WASHERS, SHOULDER WASHERS & SCREW INSULATORS

SECTION IV

SHOULDER WASHERS

Molded in Natural Nylon 6/6

Nylon Shoulder Washers are suitable for a large variety of insulation and mechanical applications.

► THEY INSULATE ► REDUCE VIBRATION ► ACT AS SPACERS AND GUIDES ► STRONG AND CORROSION RESISTANT ► CAN BE USED AS SEAL IN SOME APPLICATIONS

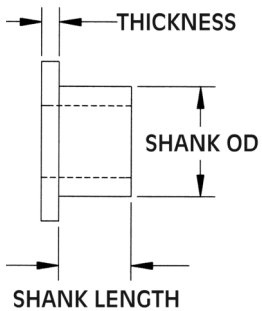
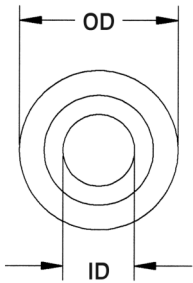

ITEM NUMBER	DESCRIPTION	SHANK LENGTH		OD		THICKNESS		SHANK OD		ID	
12SWS3505	SWS 3505	.100	(2,54)	.800	(20,32)	.055	(1,40)	.655	(16,64)	.563	(14,30)
12SWS3506	SWS 3506	.263	(6,68)	.760	(19,30)	.127	(3,23)	.370	(9,40)	.267	(6,78)
12SWS3507	SWS 3507	.250	(6,35)	.830	(21,08)	.100	(2,54)	.452	(11,18)	.253	(6,43)
12SWS3508	SWS 3508	7/16	(11,10)	.556	(14,12)	.060	(1,52)	.453	(11,51)	.377	(9,58)
12SWS3509	SWS 3509	.050	(1,27)	.775	(19,69)	.150	(3,81)	.580	(14,73)	.485	(12,32)
12SWS3510	SWS 3510	13/32	(10,32)	.825	(20,96)	3/32	(2,38)	.445	(11,30)	.306	(7,77)
12SWS3511	SWS 3511	13/64	(5,16)	.880	(22,35)	3/64	(1,19)	.750	(19,05)	.617	(15,67)
12SWS3512	SWS 3512	.935	(23,75)	.872	(22,15)	.110	(2,79)	.497	(12,62)	.385	(9,78)
12SWS3513	SWS 3513	.250	(6,35)	.875	(22,22)	.125	(3,17)	.617	(15,67)	.335	(8,51)
12SWS3514	SWS 3514	3/8	(9,53)	7/8	(22,23)	1/16	(1,57)	31/64	(12,29)	.386	(9,80)
12SWS3515	SWS 3515	3/8	(9,53)	7/8	(22,23)	1/16	(1,57)	17/32	(13,49)	.438	(11,13)
12SWS3516	SWS 3516	.406	(10,31)	.825	(20,96)	.094	(2,39)	.440	(11,18)	.311	(7,90)
12SWS3517	SWS 3517	.035	(0,89)	.625	(15,88)	.045	(1,14)	.533	(14,05)	.430	(10,92)
12SWS3518	SWS 3518	.110	(2,79)	.750	(19,05)	.075	(1,90)	.437	(11,09)	.380	(9,65)
12SWS3519	SWS 3519	.100	(2,54)	.996	(25,29)	.102	(2,59)	.645	(16,38)	.436	(11,07)
12SWS3520	SWS 3520	17/32	(13,49)	.945	(24,03)	5/64	(1,98)	.470	(11,93)	.406	(10,31)
12SWS3521	SWS 3521	.060	(1,52)	.940	(23,88)	.090	(2,29)	.560	(14,22)	.257	(6,53)
12SWS3562	SWS 3562	1/4	(6,35)	.980	(24,89)	1/8	(3,18)	.556	(14,12)	.380	(9,65)
12SWS3563	SWS 3563	.080	(2,03)	1.000	(25,40)	.125	(3,18)	.306	(7,77)	.205	(5,21)
12SWS3564	SWS 3564	.250	(6,35)	.980	(24,89)	.125	(3,18)	.546	(13,87)	.406	(10,31)
12SWS3565	SWS 3565	.618	(15,70)	.984	(24,99)	.059	(1,50)	.547	(13,89)	.398	(10,11)
12SWS3580	SWS 3580	9/16	(14,29)	1 1/4	(31,75)	3/64	(1,19)	1.00	(25,40)	.559	(14,20)
12SWS3582	SWS 3582	.688	(17,48)	1.250	(31,75)	.062	(1,57)	1.000	(25,40)	.875	(22,23)
12SWS3588	SWS 3588	.281	(7,14)	1.105	(28,07)	.125	(3,18)	.740	(18,80)	.525	(13,34)
12SWS3589	SWS 3589	.619	(15,72)	.995	(25,27)	.125	(3,18)	.740	(18,80)	.504	(12,80)
12SWS3593	SWS 3593	.340	(8,63)	1.250	(31,75)	.120	(3,04)	.750	(19,05)	.530	(13,46)
12SWS3594	SWS 3594	.125	(3,18)	.875	(22,23)	.062	(1,57)	.750	(19,05)	.566	(14,38)
12SWS3595	SWS 3595	.250	(6,35)	.875	(22,23)	.063	(1,60)	.750	(19,05)	.562	(14,29)
12SWS3596	SWS 3596	.500	(12,70)	1.000	(25,40)	.130	(3,30)	.619	(15,72)	.410	(10,41)
12SWS3597	SWS 3597	.130	(3,30)	1.000	(25,40)	.060	(1,52)	.750	(19,05)	.530	(13,46)
12SWS3598	SWS 3598	.200	(5,08)	1.000	(25,40)	.050	(1,27)	.750	(19,05)	.630	(16,00)
12SWS3599	SWS 3599	5/8	(15,88)	1"	(25,40)	1/8	(3,18)	.666	(16,92)	.520	(13,21)
12SWS3600	SWS 3600	.660	(16,76)	1.010	(25,65)	.160	(4,06)	.600	(15,24)	.260	(6,60)
12SWS3601	SWS 3601	3/16	(4,76)	1.000	(25,40)	1/4	(6,35)	.435	(11,05)	.325	(8,26)
12SWS3602	SWS 3602	1/32	(0,79)	1.000	(25,40)	3/32	(2,38)	.616	(15,65)	.515	(13,08)
12SWS3603	SWS 3603	.050	(1,27)	1.005	(25,53)	.070	(1,78)	.500	(12,70)	.453	(11,51)
12SWS3604	SWS 3604	.243	(6,17)	1.006	(25,55)	.078	(1,98)	.504	(12,80)	.376	(9,55)
12SWS3605	SWS 3605	5/16	(7,94)	1.005	(25,53)	1/16	(1,59)	.500	(12,70)	.375	(9,53)
12SWS3606	SWS 3606	.33	(8,38)	1.00	(25,40)	.04	(1,02)	.625	(15,87)	.515	(13,08)
12SWS3607	SWS 3607	.521	(13,23)	1.068	(27,13)	.062	(1,57)	.896	(22,76)	.630	(16,00)
12SWS3608	SWS 3608	.500	(12,70)	1.000	(25,40)	.125	(3,18)	.687	(17,45)	.510	(12,95)
12SWS3609	SWS 3609	.120	(3,05)	1.000	(25,40)	.130	(3,30)	.745	(18,92)	.645	(16,38)
12SWS3610	SWS 3610	9/16	(14,29)	1.000	(25,40)	1/16	(1,59)	.500	(12,70)	.382	(9,70)
12SWS3612	SWS 3612	.085	(2,16)	1.000	(25,40)	.075	(1,91)	.562	(14,27)	.190	(4,83)
12SWS3613	SWS 3613	.080	(2,03)	1.000	(25,40)	.090	(2,29)	.740	(18,80)	.219	(5,56)
12SWS3614	SWS 3614	.050	(1,27)	1.937	(49,20)	.050	(1,27)	.500	(12,70)	.453	(11,51)
12SWS3615	SWS 3615	3/4	(19,05)	1.000	(25,40)	1/8	(3,18)	.500	(12,70)	3/8	(9,53)
12SWS3616	SWS 3616	.406	(10,31)	.980	(24,89)	.150	(3,81)	.895	(22,73)	.812	(20,62)



WASHERS, SHOULDER WASHERS & SCREW INSULATORS

SHOULDER WASHERS

Molded in **Natural Nylon 6/6**

SECTION
IV

Nylon Shoulder Washers are suitable for a large variety of insulation and mechanical applications.

▶ THEY INSULATE ▶ REDUCE VIBRATION ▶ ACT AS SPACERS AND GUIDES ▶ STRONG AND CORROSION RESISTANT ▶ CAN BE USED AS SEAL IN SOME APPLICATIONS

ITEM NUMBER	DESCRIPTION	SHANK LENGTH		OD	THICKNESS		SHANK OD		ID	
12SWS3617	SWS 3617	.437	(11,10)	1.000 (25,40)	.125 (3,18)	.688 (17,47)	.508 (12,90)			
12SWS3650	SWS 3650	7/64	(2,77)	1.000 (25,40)	5/64 (1,98)	.770 (19,56)	.508 (12,90)			
12SWS3680	SWS 3680	1/16	(1,59)	1.000 (25,40)	1/16 (1,59)	.298 (7,57)	.203 (5,16)			
12SWS3683	SWS 3683	.500	(12,70)	.622 (15,79)	.062 (1,57)	.443 (11,25)	.328 (8,33)			
12SWS3684	SWS 3684	.100	(2,54)	1.250 (31,75)	.212 (5,38)	.940 (23,88)	.340 (8,64)			
12SWS3685	SWS 3685	1/16	(1,59)	1.064 (27,02)	1/16 (1,59)	.787 (19,99)	.612 (15,54)			
12SWS3686	SWS 3686	9/32	(7,14)	1.105 (28,07)	.095 (2,41)	.718 (18,24)	.515 (13,08)			
12SWS3687	SWS 3687	.118	(3,00)	1.102 (27,99)	.039 (0,99)	.906 (23,01)	.827 (21,01)			
12SWS3688	SWS 3688	.313	(7,95)	1.130 (28,70)	.062 (1,57)	.880 (22,35)	.750 (19,05)			
12SWS3689	SWS 3689	.313	(7,95)	1.130 (28,70)	.062 (1,57)	.880 (22,35)	.758 (19,25)			
12SWS3690	SWS 3690	7/16	(11,11)	1.125 (28,58)	3/32 (2,38)	.700 (17,78)	.510 (12,95)			
12SWS3691	SWS 3691	.060	(1,52)	1.160 (29,46)	.128 (3,25)	.495 (12,57)	.377 (9,58)			
12SWS3693	SWS 3693	.422	(10,72)	1.250 (31,75)	.156 (3,96)	1.002 (25,45)	.818 (20,78)			
12SWS3694	SWS 3694	.250	(6,35)	1.125 (28,58)	.187 (4,75)	.718 (18,24)	.515 (13,08)			
12SWS3695	SWS 3695	.125	(3,18)	1.250 (31,75)	.045 (1,14)	.480 (12,19)	.380 (9,65)			
12SWS3696	SWS 3696	.100	(2,54)	1.250 (31,75)	.150 (3,81)	1.000 (25,40)	.340 (8,64)			
12SWS3697	SWS 3697	.100	(2,54)	1.250 (31,75)	.212 (5,38)	1.000 (25,40)	.340 (8,64)			
12SWS3698	SWS 3698	.220	(5,59)	1.500 (38,10)	.120 (3,05)	1.000 (25,40)	.810 (20,57)			
12SWS3699	SWS 3699	.118	(3,00)	1.181 (30,00)	.079 (2,01)	.374 (9,50)	.197 (5,00)			
12SWS3998	SWS 3998	.250	(6,35)	1.248 (31,70)	.130 (3,30)	.875 (22,23)	.627 (15,93)			
12SWS3999	SWS 3999	.485	(12,32)	1.250 (31,75)	.130 (3,30)	.875 (22,23)	.480 (12,19)			
12SWS4000	SWS 4000	7/16	(11,10)	1 3/16 (30,15)	1/16 (1,59)	1 (25,40)	.766 (19,46)			
12SWS4001	SWS 4001	3/32	(2,38)	1.125 (28,58)	1/16 (1,59)	.740 (18,80)	.515 (13,08)			
12SWS4002	SWS 4002	3/32	(2,38)	1.235 (31,36)	1/16 (1,59)	.984 (24,99)	.510 (12,95)			
12SWS4003	SWS 4003	9/32	(7,14)	1.105 (28,07)	1/8 (3,18)	.752 (19,10)	.515 (13,08)			
12SWS4004	SWS 4004	1/2	(12,70)	1.245 (31,69)	1/8 (3,18)	.875 (22,23)	.627 (15,92)			
12SWS4005	SWS 4005	13/32	(10,32)	1.252 (31,80)	1/16 (1,59)	.600 (15,24)	.538 (13,66)			
12SWS4006	SWS 4006	13/32	(10,32)	1.251 (31,77)	1/16 (1,59)	.528 (13,41)	.471 (11,96)			
12SWS4007	SWS 4007	13/64	(5,16)	1.739 (44,17)	13/64 (5,16)	1.095 (27,81)	.435 (11,04)			
12SWS4008	SWS 4008	11/32	(8,71)	1.250 (31,75)	5/32 (3,97)	.995 (25,27)	.885 (22,48)			
12SWS4009	SWS 4009	3/4	(19,05)	1 1/8 (28,57)	1/16 (1,59)	7/16 (11,11)	5/16 (7,94)			
12SWS4010	SWS 4010	3/32	(2,38)	1.250 (31,75)	1/16 (1,59)	.930 (23,62)	.562 (14,27)			
12SWS4011	SWS 4011	.094	(2,39)	1.250 (31,75)	.062 (1,57)	.989 (25,12)	.562 (14,27)			
12SWS4012	SWS 4012	.060	(1,52)	1.650 (41,91)	.060 (1,52)	1.380 (35,05)	1.125 (28,58)			
12SWS4013	SWS 4013	5/8	(15,88)	1-3/4 (44,45)	1/8 (3,18)	1-3/8 (34,93)	1.015 (25,78)			
12SWS4014	SWS 4014	.238	(6,04)	1.501 (38,12)	.133 (3,38)	1.248 (31,70)	.942 (23,92)			
12SWS4016	SWS 4016	.100	(2,54)	1.250 (31,75)	.250 (6,35)	.419 (10,64)	.254 (6,45)			
12SWS4017	SWS 4017	.170	(4,32)	1.570 (39,88)	.175 (4,45)	1.055 (26,80)	.887 (22,53)			
12SWS4018	SWS 4018	.250	(6,35)	1.500 (38,10)	.120 (3,05)	.615 (15,62)	.265 (6,73)			
12SWS4019	SWS 4019	.309	(7,85)	1.365 (34,67)	.128 (3,25)	1.120 (28,45)	.870 (22,10)			
12SWS4020	SWS 4020	5/16	(7,92)	2 21/64 (59,13)	1/8 (3,18)	.968 (24,59)	.770 (19,56)			
12SWS4021	SWS 4021	.138	(3,51)	1.929 (49,00)	.079 (2,01)	1.063 (27,00)	.906 (23,01)			
12SWS4022	SWS 4022	.313	(7,95)	1.500 (38,10)	.125 (3,18)	1.365 (34,67)	1.000 (25,40)			
12SWS5000	SWS 5000	5/8	(15,88)	1.952 (49,58)	.125 (3,18)	31/64 (12,29)	.380 (9,65)			
12SWS5001	SWS 5001	1/2	(12,70)	2.065 (52,45)	1/8 (3,18)	1.050 (26,67)	.806 (20,42)			
12SWS5002	SWS 5002	.500	(12,70)	2.065 (52,45)	.125 (3,18)	1.050 (26,67)	.783 (19,89)			
12SWS5003	SWS 5003	.305	(7,75)	1.989 (50,52)	.129 (3,28)	1.743 (44,27)	1.326 (33,68)			
12SWS5009	SWS 5009	45/64	(17,85)	2.111 (53,62)	1/8 (3,18)	.603 (15,31)	.270 (6,85)			
12SWS5050	SWS 5050	1/2	(12,70)	1.525 (38,74)	1/16 (1,57)	3/4 (19,05)	.645 (16,38)			

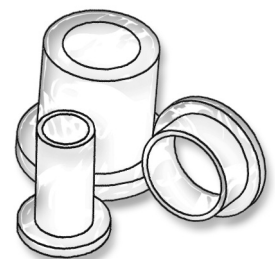
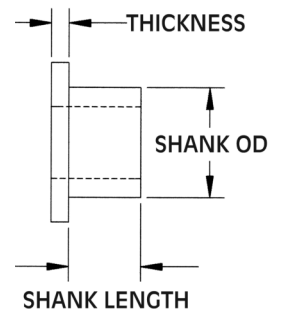
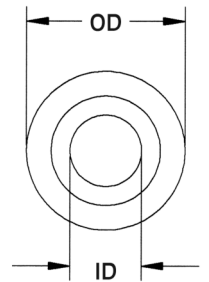

WASHERS, SHOULDER WASHERS & SCREW INSULATORS

SECTION IV

These nylon washers are designed to prevent the loss of screws and bolts and to protect surfaces. The washer allows preliminary mounting of the bolt before securing with a nut. The tapered part of the washer provides locking to the screwed assembly. The tapered part of the washer cold forms and fully enters the pitch of the screw to provide sealing. The tapered part is a smaller diameter than the screw and is used to retain the screw before assembly.

Compares to "Dubo" washers.

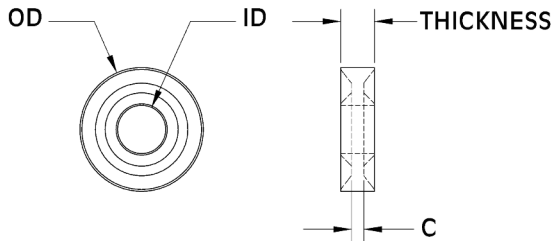

New SIZE

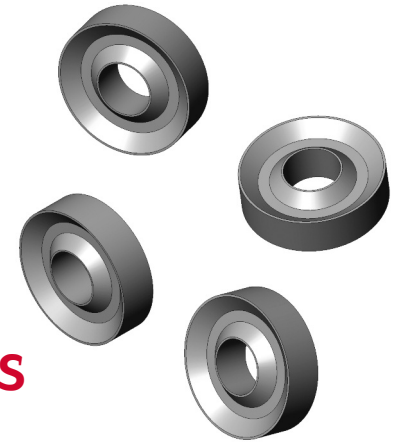

SEALING AND RETAINING RINGS WASHERS

Molded in **Natural Nylon 6/6**

ITEM NUMBER	FITS SCREW	OD	ID	THICKNESS	C Ref.
16SRRW004209083	4	.321 (8,15)	.125 (3,20)	.088 (2,24)	.032 (0,81)
16SRRW006354150	6	.363 (9,22)	.154 (3,91)	.095 (2,41)	.037 (0,94)
16SRRW008374163	8	.380 (9,65)	.161 (4,09)	.103 (2,62)	.039 (0,99)
16SRRW010421200	10	.421 (10,69)	.200 (5,08)	.120 (3,05)	.060 (1,52)
16SRRW025500242	1/4	.500 (12,70)	.242 (6,15)	.139 (3,53)	.070 (1,78)
16SRRW025500256	1/4	.505 (12,82)	.256 (6,50)	.139 (3,53)	.070 (1,77)
16SRRW031637318	5/16	.640 (16,26)	.318 (8,08)	.158 (4,01)	.060 (1,52)
16SRRW037771381	3/8	.775 (19,70)	.381 (9,68)	.177 (4,50)	.070 (1,78)
16SRRW050100504	1/2	1.000 (25,40)	.504 (12,80)	.197 (5,00)	.079 (2,01)

Spring washers are molded in acetal material that has excellent spring properties, is light weight and inexpensive. The material is electrical and thermal insulating and corrosion resistant. Acetal lubricity allows use in rotating assemblies as well as underwater applications. Spring washers are used to eliminate rattles, take up tolerance variables and provide accurate spacing and tension. May be used singly in parallel, in series or in series parallel for a wide range of deflection and load capacity.

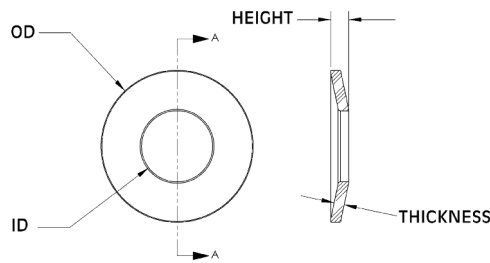

New SIZE

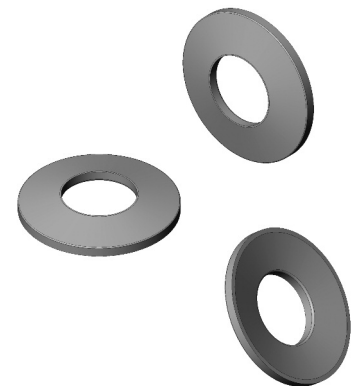

SPRING WASHERS

Molded in **Natural Acetal**

ITEM NUMBER	SCREW SIZE		OD	ID	HEIGHT	THICKNESS	MAX. REF. COMPRESSED OD
	INCH	METRIC					
17SPRINGW100	6	M3.5	.316 (8,03)	.152 (3,86)	.045 (1,14)	.027 (0,69)	.330 (8,38)
17SPRINGW200	8	M4	.297 (7,54)	.173 (4,39)	.046 (1,17)	.028 (0,79)	.310 (7,87)
17SPRINGW300	10	M5	.365 (9,27)	.204 (5,18)	.053 (1,35)	.030 (0,76)	.372 (9,45)
17SPRINGW320	10	M5	.416 (10,57)	.235 (5,97)	.062 (1,57)	.035 (0,89)	.430 (10,92)
17SPRINGW360	1/4	M6	.448 (11,37)	.276 (7,01)	.062 (1,57)	.035 (0,89)	.485 (12,31)
17SPRINGW400	1/4	M6	.564 (14,33)	.264 (6,71)	.066 (1,68)	.038 (0,97)	.579 (14,71)
17SPRINGW500	5/16	M8	.660 (16,76)	.328 (8,33)	.080 (2,03)	.048 (1,22)	.680 (17,27)
17SPRINGW600	3/8	M10	.848 (21,54)	.451 (11,46)	.095 (2,41)	.055 (1,40)	.865 (21,97)

WASHERS, SHOULDER WASHERS & SCREW INSULATORS

SCREW INSULATORS

Molded in **Natural Nylon 6/6**

SECTION
IV

METRIC Sizes
Also Available
Page 278

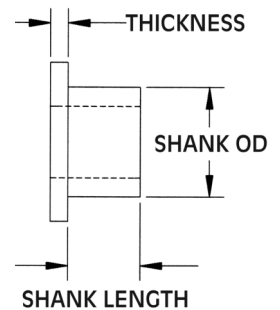
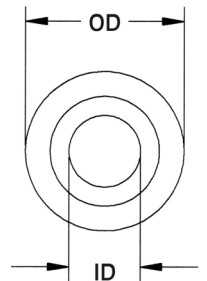
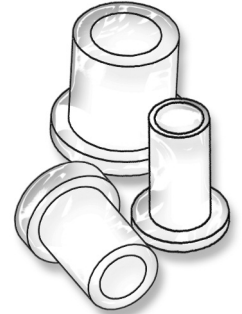

Screw Insulators may also be used as light load bearings in many applications. Specify screw size and length when ordering.

Specials can be made to order for a small tooling charge.

ITEM NUMBER	SCREW SIZE	SHANK LENGTH	OD	THICKNESS	SHANK OD	ID
10SC002012	2	1/8 (3,18)	.181 (4,60)	3/64 (1,19)	.120 (3,05)	.090 (2,29)
10SC002018	2	3/16 (4,76)	.181 (4,60)	3/64 (1,19)	.120 (3,05)	.090 (2,29)
10SC002025	2	1/4 (6,35)	.181 (4,60)	3/64 (1,19)	.120 (3,05)	.090 (2,29)
10SC002037	2	3/8 (9,53)	.181 (4,60)	3/64 (1,19)	.120 (3,05)	.090 (2,29)
10SC004003	4	1/32 (0,79)	.235 (5,97)	3/64 (1,19)	.145 (3,68)	.115 (2,92)
10SC004004	4	3/64 (1,19)	.235 (5,97)	3/64 (1,19)	.145 (3,68)	.115 (2,92)
10SC004006	4	1/16 (1,59)	.235 (5,97)	3/64 (1,19)	.145 (3,68)	.115 (2,92)
10SC004009	4	3/32 (2,38)	.235 (5,97)	3/64 (1,19)	.145 (3,68)	.115 (2,92)
10SC004012	4	1/8 (3,18)	.235 (5,97)	3/64 (1,19)	.145 (3,68)	.115 (2,92)
10SC004015	4	5/32 (3,97)	.235 (5,97)	3/64 (1,19)	.145 (3,68)	.115 (2,92)
10SC004018	4	3/16 (4,76)	.235 (5,97)	3/64 (1,19)	.145 (3,68)	.115 (2,92)
10SC004025	4	1/4 (6,35)	.235 (5,97)	3/64 (1,19)	.145 (3,68)	.115 (2,92)
10SC004037	4	3/8 (9,53)	.235 (5,97)	3/64 (1,19)	.145 (3,68)	.115 (2,92)
10SC004050	4	1/2 (12,70)	.235 (5,97)	3/64 (1,19)	.145 (3,68)	.115 (2,92)
10SC006004	6	3/64 (1,19)	.290 (7,37)	3/64 (1,19)	.170 (4,32)	.140 (3,56)
10SC006006	6	1/16 (1,59)	.290 (7,37)	3/64 (1,19)	.170 (4,32)	.140 (3,56)
10SC006009	6	3/32 (2,38)	.290 (7,37)	3/64 (1,19)	.170 (4,32)	.140 (3,56)
10SC006012	6	1/8 (3,18)	.290 (7,37)	3/64 (1,19)	.170 (4,32)	.140 (3,56)
10SC006015	6	5/32 (3,97)	.290 (7,37)	3/64 (1,19)	.170 (4,32)	.140 (3,56)
10SC006018	6	3/16 (4,76)	.290 (7,37)	3/64 (1,19)	.170 (4,32)	.140 (3,56)
10SC006025	6	1/4 (6,35)	.290 (7,37)	3/64 (1,19)	.170 (4,32)	.140 (3,56)
10SC006037	6	3/8 (9,53)	.290 (7,37)	3/64 (1,19)	.170 (4,32)	.140 (3,56)
10SC006050	6	1/2 (12,70)	.290 (7,37)	3/64 (1,19)	.170 (4,32)	.140 (3,56)
10SC008012	8	1/8 (3,18)	.344 (8,74)	1/16 (1,59)	.205 (5,21)	.173 (4,39)
10SC008014	8	9/64 (3,58)	.344 (8,74)	1/16 (1,59)	.205 (5,21)	.173 (4,39)
10SC008025	8	1/4 (6,35)	.344 (8,74)	1/16 (1,59)	.205 (5,21)	.173 (4,39)
10SC008037	8	3/8 (9,53)	.344 (8,74)	1/16 (1,59)	.205 (5,21)	.173 (4,39)
10SC008050	8	1/2 (12,70)	.344 (8,74)	1/16 (1,59)	.205 (5,21)	.173 (4,39)
10SC008062	8	5/8 (15,88)	.344 (8,74)	1/16 (1,59)	.205 (5,21)	.173 (4,39)
10SC008075	8	3/4 (19,05)	.344 (8,74)	1/16 (1,59)	.205 (5,21)	.173 (4,39)
10SC010006	10	1/16 (1,59)	.399 (10,13)	1/16 (1,59)	.260 (6,60)	.200 (5,08)
10SC010014	10	9/64 (3,58)	.399 (10,13)	1/16 (1,59)	.260 (6,60)	.200 (5,08)
10SC010018	10	3/16 (4,76)	.399 (10,13)	1/16 (1,59)	.260 (6,60)	.200 (5,08)
10SC010025	10	1/4 (6,35)	.399 (10,13)	1/16 (1,59)	.260 (6,60)	.200 (5,08)
10SC010037	10	3/8 (9,53)	.399 (10,13)	1/16 (1,59)	.260 (6,60)	.200 (5,08)
10SC010050	10	1/2 (12,70)	.399 (10,13)	1/16 (1,59)	.260 (6,60)	.200 (5,08)
10SC010056	10	9/16 (14,29)	.399 (10,13)	1/16 (1,59)	.260 (6,60)	.200 (5,08)
10SC010062	10	5/8 (15,88)	.399 (10,13)	1/16 (1,59)	.260 (6,60)	.200 (5,08)
10SC010075	10	3/4 (19,05)	.399 (10,13)	1/16 (1,59)	.260 (6,60)	.200 (5,08)
10SC250012	1/4	1/8 (3,18)	.513 (13,03)	1/16 (1,59)	.312 (7,92)	.260 (6,60)
10SC250014	1/4	9/64 (3,58)	.513 (13,03)	1/16 (1,59)	.312 (7,92)	.260 (6,60)
10SC250018	1/4	3/16 (4,76)	.513 (13,03)	1/16 (1,59)	.312 (7,92)	.260 (6,60)
10SC250025	1/4	1/4 (6,35)	.513 (13,03)	1/16 (1,59)	.312 (7,92)	.260 (6,60)
10SC250032	1/4	1/4 (6,35)	.513 (13,03)	1/32 (0,79)	.312 (7,92)	.260 (6,60)
10SC250037	1/4	3/8 (9,53)	.513 (13,03)	1/16 (1,59)	.312 (7,92)	.260 (6,60)
10SC250050	1/4	1/2 (12,70)	.513 (13,03)	1/16 (1,59)	.312 (7,92)	.263 (6,68)
10SC250062	1/4	5/8 (15,88)	.513 (13,03)	1/16 (1,59)	.312 (7,92)	.260 (6,60)
10SC250075	1/4	3/4 (19,05)	.513 (13,03)	1/16 (1,59)	.312 (7,92)	.260 (6,60)
10SC312012	5/16	1/8 (3,18)	.620 (15,75)	1/16 (1,59)	.360 (9,14)	.320 (8,13)
10SC312025	5/16	1/4 (6,35)	.620 (15,88)	1/16 (1,59)	.360 (9,14)	.320 (8,13)
10SC312037	5/16	3/8 (9,53)	.620 (15,75)	1/16 (1,59)	.360 (9,14)	.320 (8,13)
10SC312050	5/16	1/2 (12,70)	.620 (15,75)	1/16 (1,59)	.360 (9,14)	.320 (8,13)
10SC312062	5/16	5/8 (15,88)	.620 (15,75)	1/16 (1,59)	.360 (9,14)	.320 (8,13)



WASHERS, SHOULDER WASHERS & SCREW INSULATORS

SECTION IV

Nylon Cup Washers are designed to :

- Protect the head of a metal screw from electrical contact.
- Accommodate the most common screw head-styles including: Cheese, Pan and Fillister, in sizes from #4 TO 1/4".

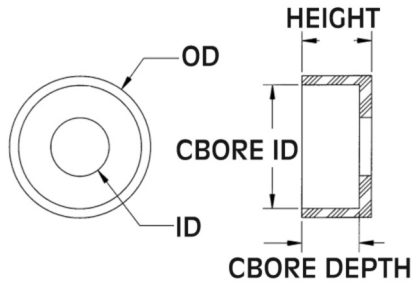

New SIZES

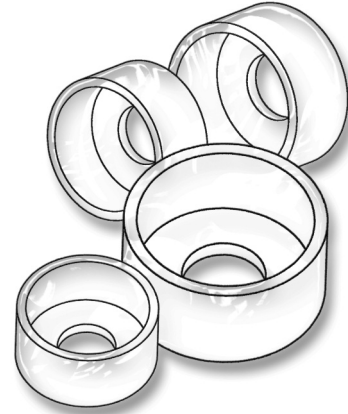

CUP WASHERS

Molded in **Natural Nylon 6/6**

ITEM NUMBER	FITS SCREW	OD	CBORE ID	ID	CBORE DEPTH	HEIGHT
16CW004257	4	.305 (7,74)	.245 (6,22)	.115 (2,92)	.217 (5,51)	.257 (6,52)
16CW004040	4	.305 (7,76)	.245 (6,22)	.115 (2,92)	.117 (2,97)	.157 (3,99)
16CW006040	6	.360 (9,14)	.300 (7,62)	.140 (3,56)	.142 (3,61)	.182 (4,62)
16CW008040	8	.414 (10,52)	.354 (8,99)	.171 (4,34)	.166 (4,22)	.206 (5,23)
16CW008042	8	.497 (12,62)	.389 (9,88)	.187 (4,75)	.093 (2,36)	.139 (3,53)
16CW008041	8	.414 (10,52)	.354 (8,99)	.171 (4,34)	.130 (3,30)	.170 (4,32)
16CW010030	10	.568 (14,43)	.375 (9,53)	.201 (5,11)	.127 (3,23)	.157 (3,99)
16CW010040	10	.470 (11,94)	.410 (10,41)	.194 (4,93)	.190 (4,83)	.230 (5,85)
16CW250250	1/4	1.000 (25,4)	.500 (12,70)	.260 (6,60)	.150 (3,81)	.198 (5,03)
16CW250040	1/4	.595 (15,11)	.535 (13,59)	.257 (6,53)	.247 (6,27)	.287 (7,29)
16CW312050	1/2	.500 (12,70)	.400 (10,16)	.320 (8,12)	.122 (3,09)	.170 (4,31)
16CW312375	5/16	.875 (22,23)	.625 (15,88)	.344 (8,74)	.250 (6,35)	.375 (9,53)
16CW312500	5/16	.875 (22,23)	.625 (15,88)	.344 (8,74)	.378 (9,60)	.500 (12,70)
16CW375225	3/8	1.000 (25,4)	.750 (19,05)	.380 (9,65)	.125 (3,18)	.225 (5,72)

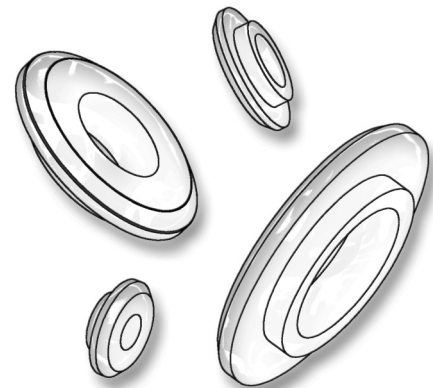
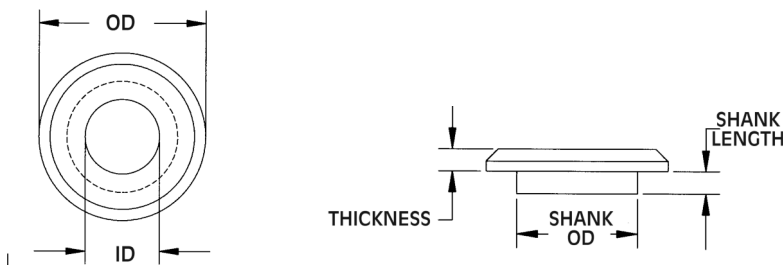

STANDARD SHOULDER WASHERS

Molded in **Natural Nylon 6/6**

ITEM NUMBER	DESCRIPTION	SCREW SIZE	SHANK LENGTH	OD	THICKNESS	SHANK OD	ID
24SW0002	SW 2	2	.040 (1,02)	.250 (6,35)	.040 (1,02)	.156 (3,96)	.093 (2,36)
24SW0004	SW 4	4	.040 (1,02)	.281 (7,14)	.040 (1,02)	.187 (4,75)	.122 (3,09)
24SW0006	SW 6	6	.040 (1,02)	.328 (8,33)	.040 (1,02)	.218 (5,54)	.146 (3,71)
24SW0008	SW 8	8	.050 (1,27)	.375 (9,53)	.050 (1,27)	.250 (6,35)	.174 (4,42)
24SW0010	SW 10	10	.050 (1,27)	.437 (11,10)	.050 (1,27)	.281 (7,14)	.201 (5,11)
24SW0250	SW1/4	1/4	.060 (1,52)	.562 (14,27)	.060 (1,52)	.375 (9,53)	.260 (6,60)
24SW0375	SW3/8	3/8	.060 (1,52)	.750 (19,05)	.060 (1,52)	.500 (12,70)	.385 (9,78)